

ARGAL

CHEMICAL PUMPS

FRONTIERA RANGE - ISO 2858

"INTRASET SYSTEM"

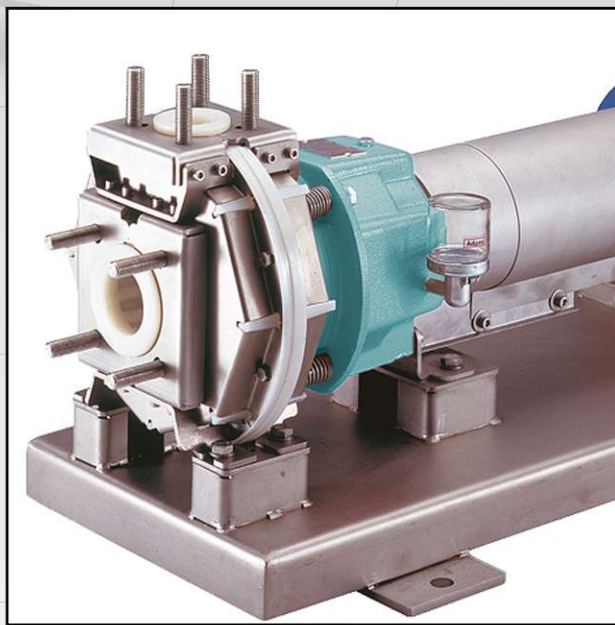

TGF

ZGF



TMF

ZMF

sealless or sealed pumps

ARGAL CENTRIFUGAL PUMPS FOR LIQUID CHEMICALS

Argal has been manufacturing centrifugal horizontal and vertical pumps in thermoplastic corrosion-resistant resins. This catalogue brings you the new FRONTIERA series of chemical pumps. They have been designed to respond positively to the requirements of the chemical and pharmaceutical industries as they can be used for different environmental applications, surface treatments, industrial washing and can handle all other uses of highly corrosive fluids as well.

INTRASET

The FRONTIERA pumps have an innovative internal structure developed by Argal upon years of direct experience in the field and they are part of the INTRASET project.

INTRASET is a two-level system:

Level 1, structure. Different mechanical sections are designed and engineered to form centrifugal pump units (close or long-coupled, with magnetic or mechanical drive, armoured or integral, etc);
Level 2, applications. The needs of the individual user are catered for by the configurations of the pumps whilst the guided settings set out in the different sections of this catalogue (and/or of the other interactive multimedia tools) enable the pump model to be defined stage by stage until the correct final model is created.
ARGAL's Quality Assurance System has been registered to ISO 9001:2000.



Frontiera pump:
armoured, magnetical version,
long-coupled.



GENERAL PERFORMANCE CURVES 50 AND 60 HZ

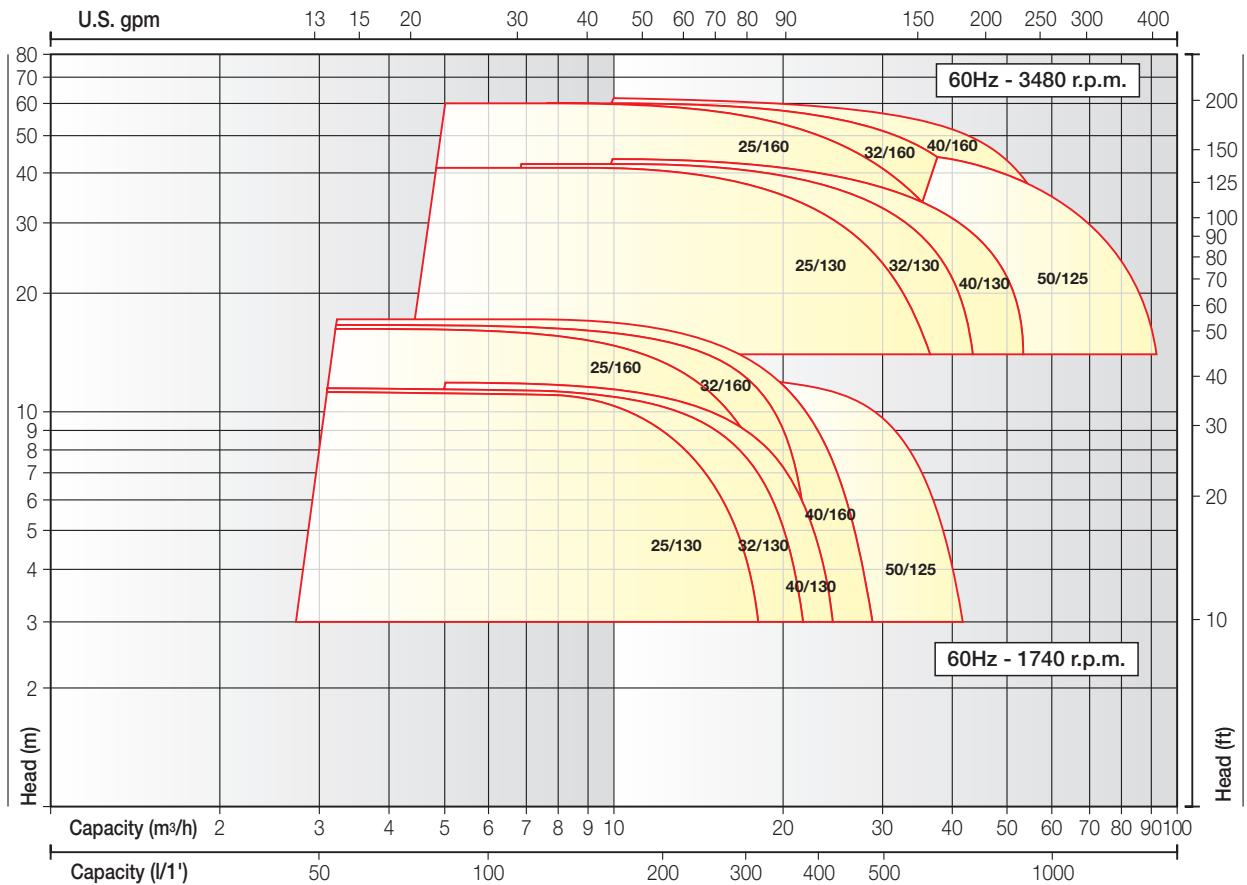
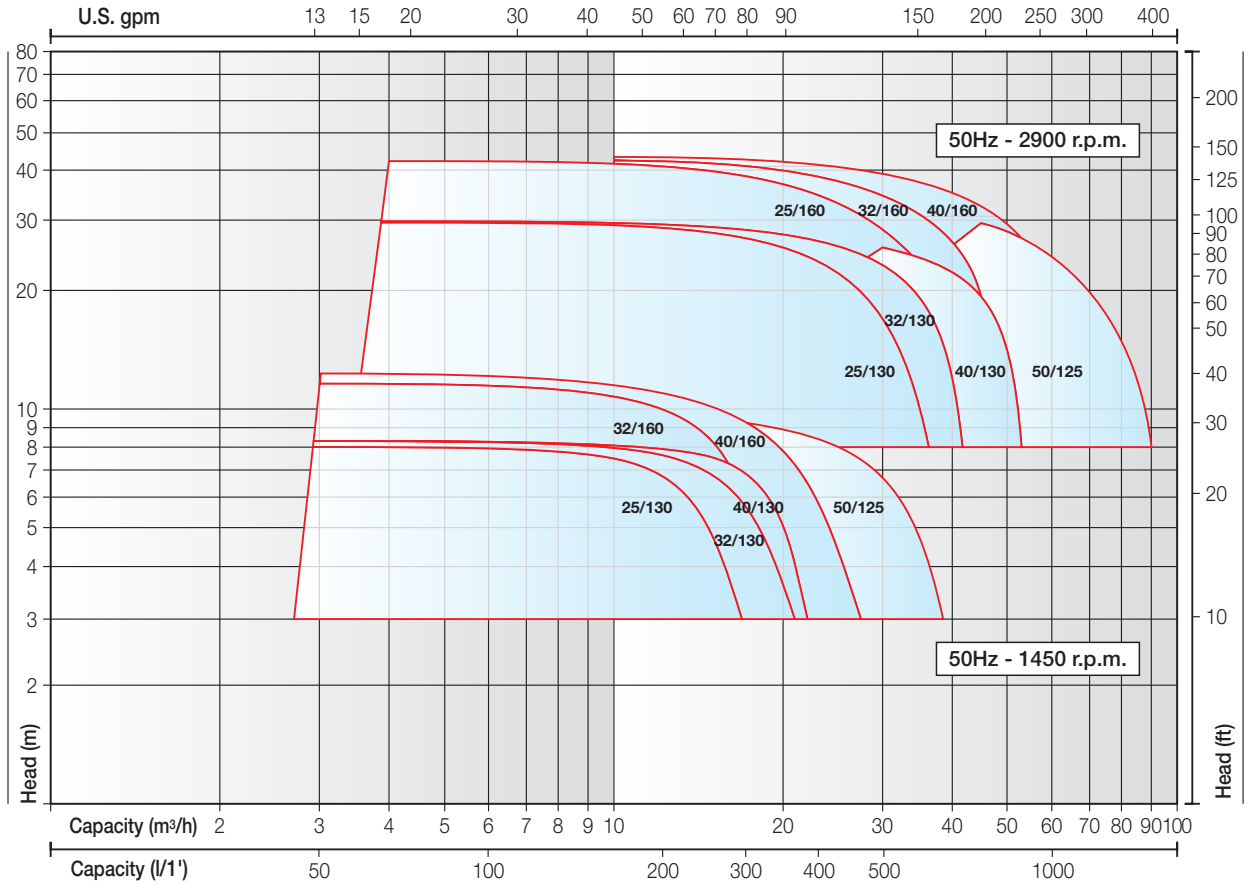

FEATURES OF FRONTIERA PUMPS

- Conform to international standards ISO 2858 (DIN 24256 - BS5257)
The standards refer to the pump size, bases, couplings, size of inlet/outlet connections and performance of each pump.

CHEMICALLY RESISTANT

All the components that come into contact with pumped liquids are exceptionally resistant to chemicals.

The polymers used in the standard versions of the volute casings and impellers are:

- Polypropylene (PPH), a pure thermoplastic material with ultra-violet ray stabiliser;
- Ethylene-chlorotrifluoroethylene (E-CTFE), a fluorinated polymer that is free of any additives.

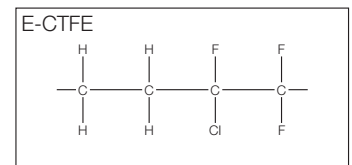
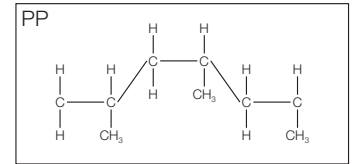

MAGNETIC DRIVE OR SEALED PUMPS

The Frontiera pumps are centrifugal and basically consist in a casing (volute casing) where a bladed impeller rotates, driven by the motor.

Version may be of 2 types: magnetic or mechanical.

- 1 In the case of magnetic drive the impeller is not fixed to the motor shaft and is rotated by magnetic force exerted by magnets placed on the motor shaft which, on their turn, pull other magnets embedded in the impeller itself. This version does not require any type of rolling seal: the volute casing is hermetically sealed only by means of static washers (O-rings) that are housed in the couplings.
- 2 In the sealed version the impeller is fitted into the motor shaft (of the electric motor or the support) and the leakage on the motor is prevented by sliding washers (mechanical seals) in appropriate material.

DIFFERENT SOLUTION INSIDE THE VOLUTE CASING

The magnetic drive pumps come with different internal structures:

- **T** (standard) for clean liquid chemicals
- **R** (critical) for frequent risks of dry operation or cavitation risks
- 3 • **X** (extreme) for liquid chemicals with suspended solids

The sealed pumps can be fitted with the usual commercially available mechanical seals with combinations of material that suit all types of liquid:

- 4 • external seals washed by pumped liquid
- internal seals (also washed externally)
- double seals washed externally

SPECIAL CARE OF PUMP INTERNAL PARTS

For magnetic driven pumps:

- hydrodynamic balancing of impeller;
- 5 • magnets housing and protection;
 - 6 • volute casing with double rear chamber: one for chemical resistance and the other to increase mechanical strength;
 - 7 • great attention to safety during dismantling and reassembling of magnetic coupling through use of springs that gradually weaken the attraction of the magnet pairs in order to prevent danger to the operator and/or damage through involuntary blows of the hydraulic parts.

For sealed pumps:

- internal circulation to cool mechanical seal and take any solid bodies to the edge of the rear casing;
- 8 • composite structure of rear disk: the thermoplastic material is reinforced inside by a stainless-steel core (that does not come into contact with the liquid) as far as the fixed seat of the mechanical seal;
 - a roller bearing efficiently supports the dynamic stress on the impeller in every pump versions (including close-coupled versions).

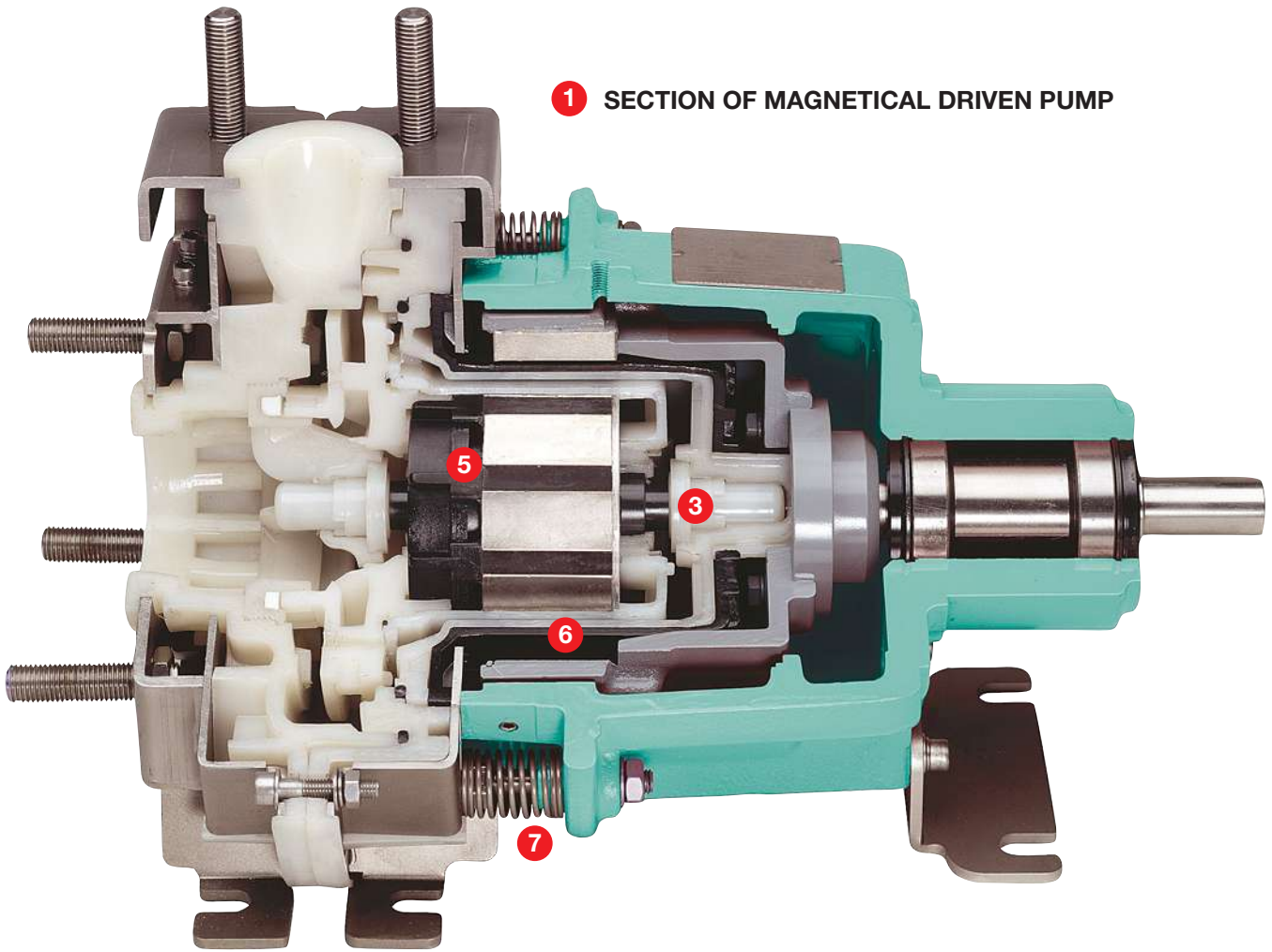

1 SECTION OF MAGNETICAL DRIVEN PUMP

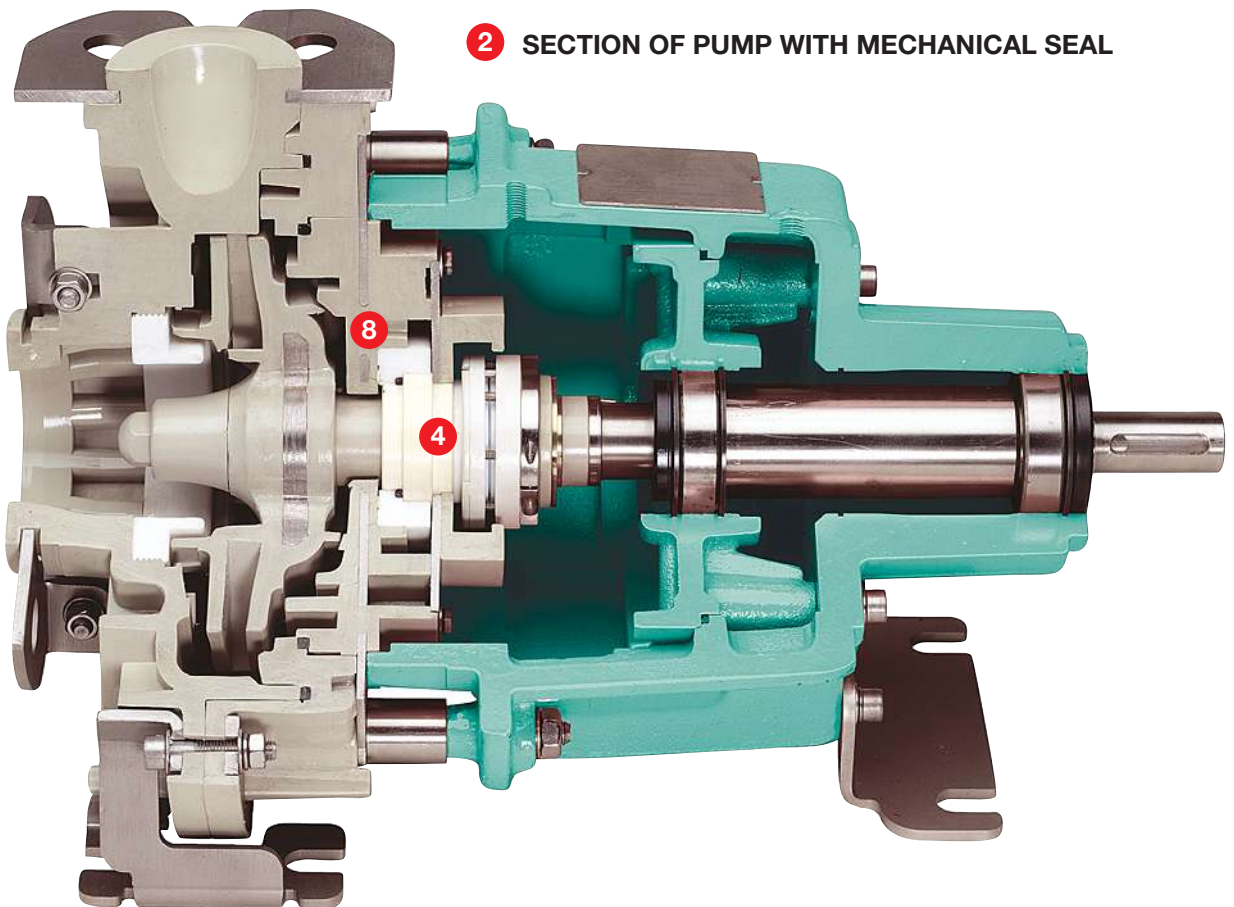

2 SECTION OF PUMP WITH MECHANICAL SEAL

INNOVATIVE EXTERNAL STRUCTURE OF STAINLESS-STEEL SHEETING

- 1 • For the entire range, the ground supports of the pump are in AISI 304 sheeting. This gives stability to the anchor bolts and prolongs the pump's life.
- 2 • In the **N**-series "integral" pump (traditional pump only in thermoplastic) stainless steel replaces the traditional plastic flanges and the special design of the fastening fittings minimises the mechanical load exerted on the volute casing.
- 3 • In the "armoured" **R** series the stainless steel sheeting replaces entirely the old cast iron armour that often deteriorates after only a short period. The new armour (that is not drawn but only folded with tools of a radius that are appropriate to the thickness) both supports the loads on the inlet/outlet fittings and protects the volute casing from internal liquid hammers and from accidental external blows;
- 4 • The bases are in stainless steel replacing the traditional sections in painted steel;
- 5 • The circular safety guards that cover the flexible coupling are in stainless-steel sheeting.

ALSO IN CLOSE-COUPLED VERSION

- 6 • A close-coupled version of the Frontiera pumps is available that enables IEC or NEMA-standard motors to be directly flanged onto the pump unit.
- 7 • For all the magnetic and mechanical versions, this connection can also be made remotely without any dismantling of the pump unit. A rolling-contact bearing in the intermediate support guides the shaft supporting the impeller and absorbs its dynamic loads.

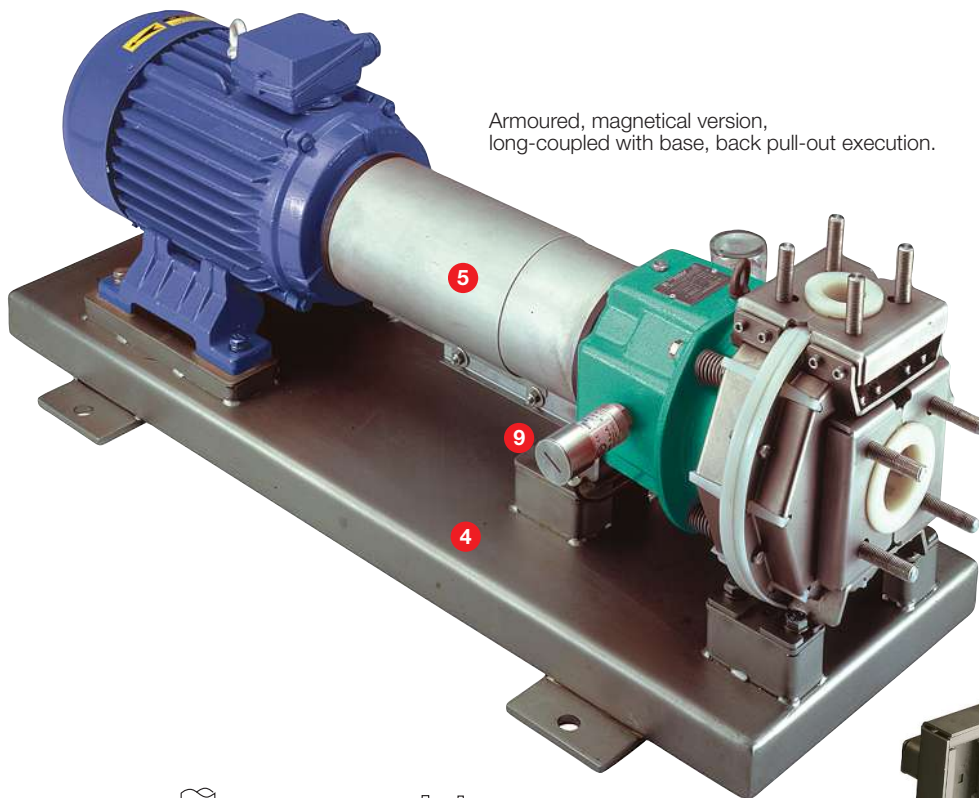

Armoured, magnetical version, long-coupled with base, back pull-out execution.



Integral version (only plastic), sealed, close-coupled execution.

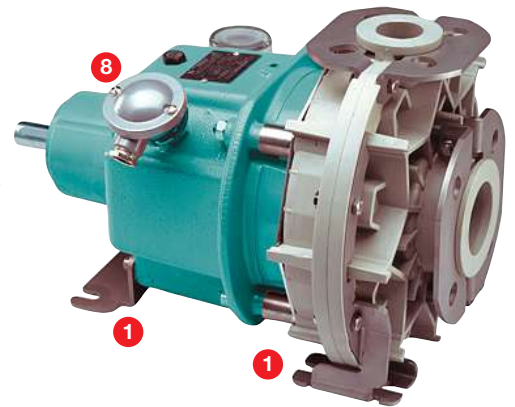

Integral version (only plastic), sealed, long-coupled execution.

ACCESSORIES

- Drain plug connection
- Dry run protector
- 8 • Temperature control
- 9 • Vibration control
- Support loses ceck control
- Insulation of pump bodies
- ! Further info: page 18

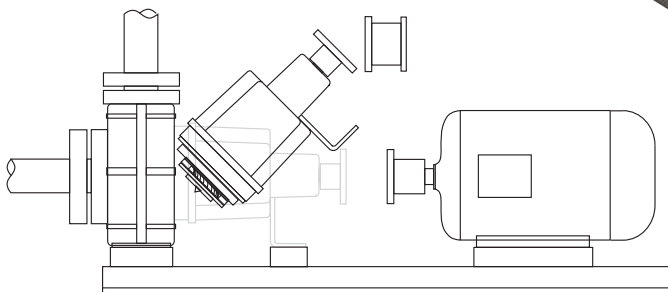

Execution "Back pull-out"

All the "Frontiera" pumps with elastic joint are equipped with the back pull out system that allows the dismantling of the internal and mechanic parts of the pump without disconnecting the body from the fittings and without moving the motor. The re-assembling process is therefore simplified.



THE TECHNICAL BASE

In the "Frontiera" project the base for the group motor pump is the outcome of advanced technics. The result is the maximum modularity with preassembled parts for an industrialised product, with robustness and stability obtained through the right reinforcements.

SOLUTIONS ON THE MARKET

The market essentially offers two solutions:

- **"Integral" Pumps**

The bodies are produced from semi-finished or preformed rough shapes of top thickness as a means of mechanical works, contained in cast iron flanges. This solution offers advantages in the robustness of the chemical resistant parts but has uneconomic results, especially for the production with fluoro polymers (PVDF, E-CTFE).

- **"Lined" Pumps**

The Lined technic consists in coating the in cast iron body with fluoro polymer. The mentioned coating, in continual form, is of low thickness and must be accurately anchored to the body of the pump to avoid the risk of detachment in the various phases of work. This solution offers economical advantages but is thrown off balance in the connection between the chemical resistant parts with the limitation of low thickness and the mechanical parts in cast iron in superfluous predominance.

THE ALTERNATIVE ARGAL

The technical solution proposed by Argal is searching for the functionality of the components and, overturning these last parameters: the body of the pump is of fluoro polymer shape, self supporting, of medium thickness (8-10 mm.) that is eventually lined with a solid armour.

The result is a more suitable pump for the work and necessities of the application of the chemical pumps:

- High thickness and robustness of the parts in contact with aggressive fluids.
- The armours give particular efficiency against attacks on the fittings and on the base of anchorage.
- Indisputables advantages of stainless steel in comparison to cast iron regarding the resistance to chemical aggression of the environment or caused by leakage.

Remarkable technical solution

The complete casing (know also as wet end) of any magnetically driven pump Frontiera, can be easily detached from all other mechanical parts as a whole and without open it.

The wet end "as it is", its also an economically sound alternative to the complete spare pump.

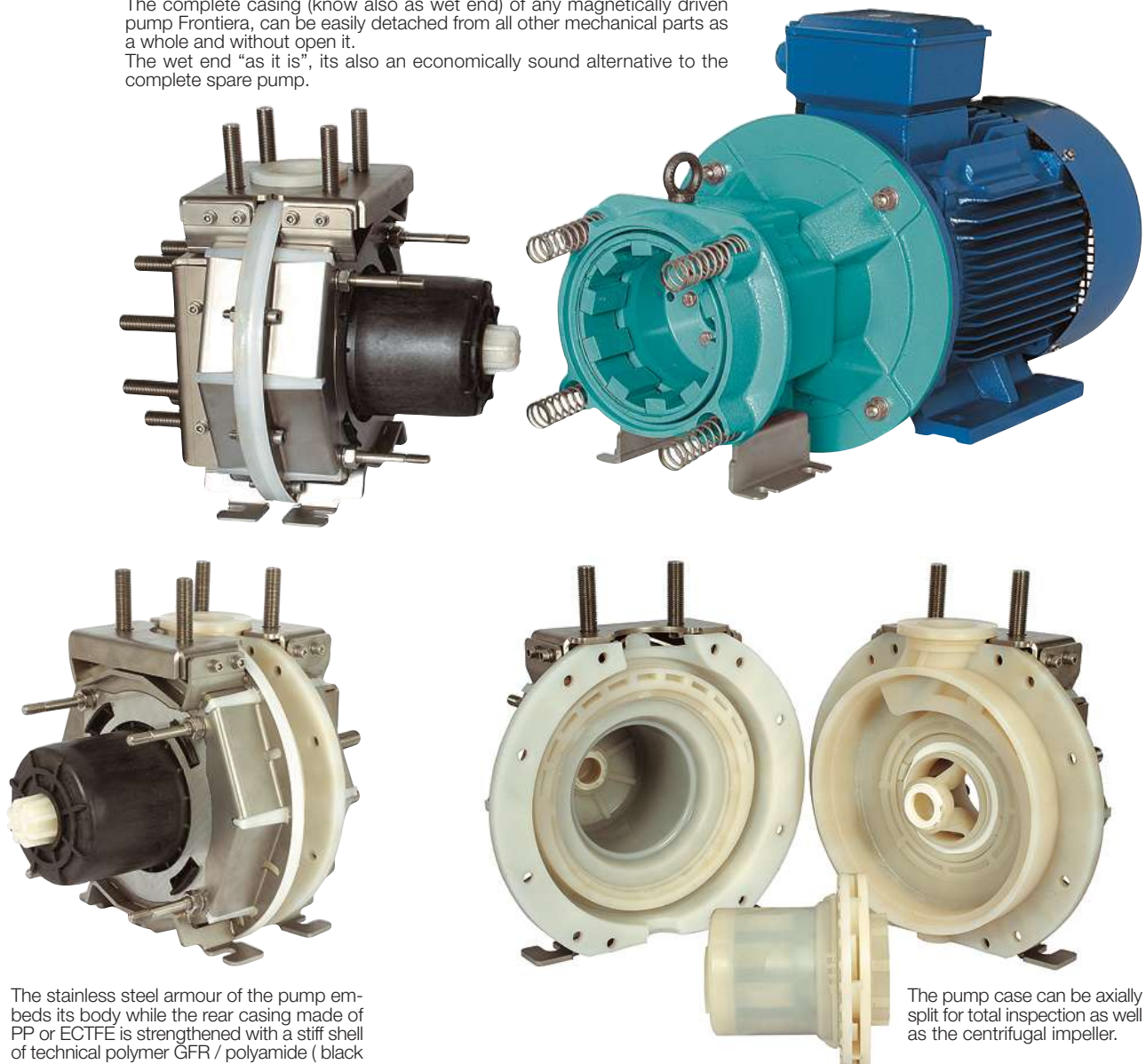

The stainless steel armour of the pump embeds its body while the rear casing made of PP or ECTFE is strengthened with a stiff shell of technical polymer GFR / polyamide (black coloured).

The pump case can be axially split for total inspection as well as the centrifugal impeller.

SEALLESS VERSION - MAIN COMPONENTS

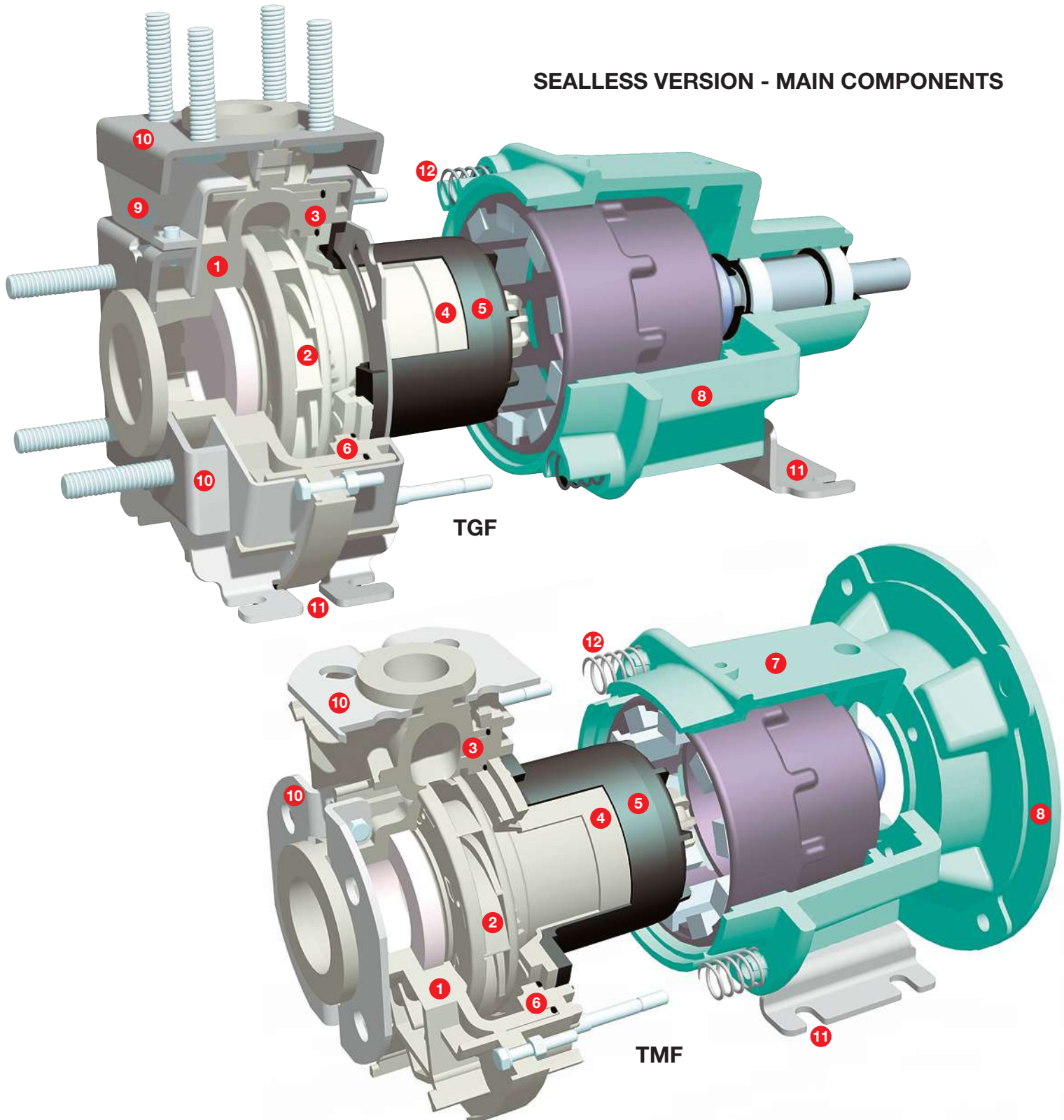
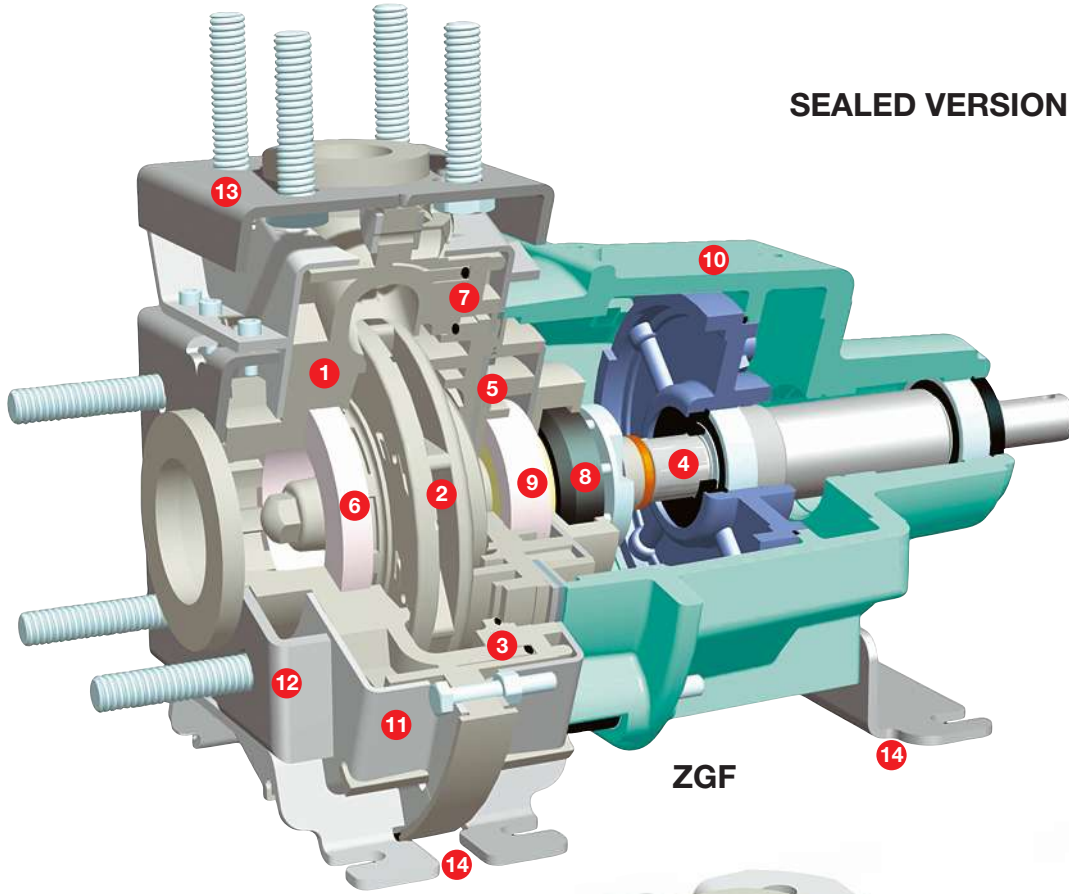

table 1

	PARTS	STANDARD VERSIONS			ATEX VERSIONS	
		WW	GF	WF	WX	GX
1	VOLUTE CASING	PP	E-CTFE	PP	PP	E-CTFE
2	IMPELLER	PP	E-CTFE	E-CTFE	PP	E-CTFE
3	INTERMEDIATE CASING	PP	E-CTFE	PP	PP	E-CTFE
4	REAR CASING	PP	E-CTFE	PP	PP	E-CTFE
5	STIF SHELL	GFR/POLYAMIDE				
6	FIXED O-RINGS	FKM				
7	SUPPORT					
8	FLANGE FOR IEC MOTOR	CAST IRON				
	FLEXIBLE COUPLING	STEEL				
9	PUMP ARMOUR					
10	FLANGES					
11	FEET	STAINLESS STEEL				
	COUPLING-COVER					
12	ASSEMBLY SPRING					

SEALED VERSION - MAIN COMPONENTS



ZGF

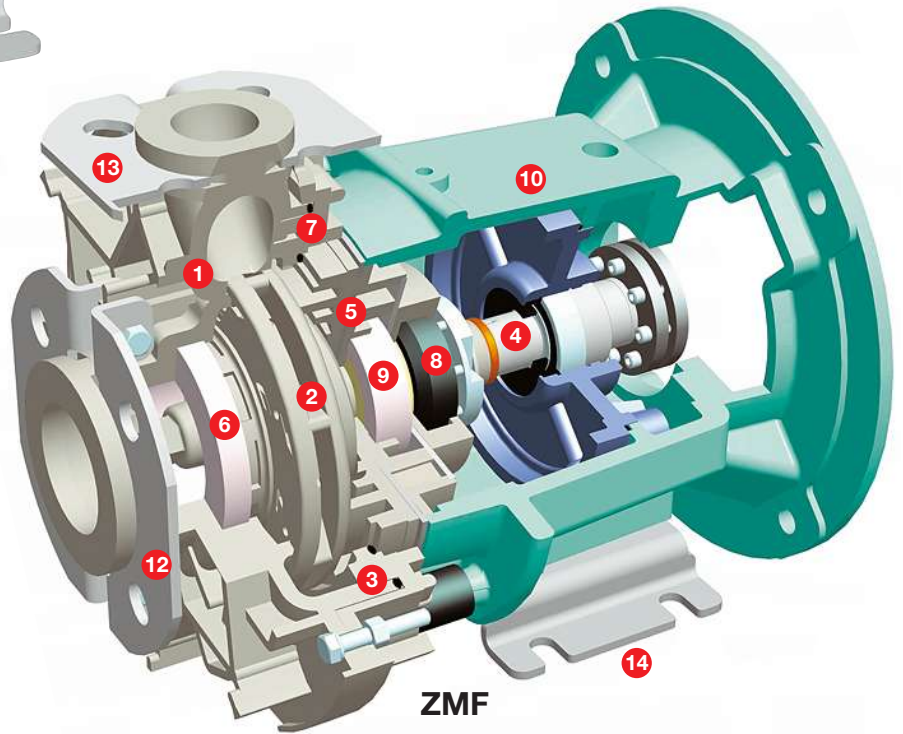

ZMF

table 2

PARTS	STANDARD VERSIONS			ATEX VERSIONS	
	WW	GF	WF	WX	GX
1 VOLUTE CASING	PP	E-CTFE	PP	PP	E-CTFE
2 IMPELLER	PP	E-CTFE	E-CTFE	PP	E-CTFE
3 INTERMEDIATE CASING	PP	E-CTFE	PP	PP	E-CTFE
4 SHAFT SLEEVE	PP	E-CTFE	PP	PP	E-CTFE
5 REAR DISK	PP	E-CTFE	PP	PP	E-CTFE
6 WEAR RING	PTFE				
7 FIXED O-RINGS	FKM				
8 MECHANICAL SEAL	see table 5-6				
9 FIXED SEAL RING	see table 6				
10 BEARING SUPPORT	CAST IRON				
11 FLEXIBLE COUPLING	STEEL				
12 PUMP ARMOUR	STAINLESS STEEL				
13 INLET FLANGE					
14 OUTLET FLANGE					
15 FEET					
16 COUPLING-COVER					

The materials

Standard versions

table 3

WW	POLYPROPYLENE	U.V. stabilized Polypropylene.
GF	E-CTFE	Ethylene-Trifluorochloroethylene.
WF	PP / E-CTFE	Polypropylene (casing) /Ethylene-Trifluorochloroethylene (impeller).

Other labels in this catalog:

CER	Alumina ceramic 99,7% high purity
CARBON H.D.	Carbon high density
SiC	Silicon Carbide
PTFE	Polytetrafluoroethylene

Atex versions

WX	POLYPROPYLENE	UV stabilized Polypropylene.
GX	E-CTFE	Ethylene - Trifluorochloroethylene.

Static elastomers

V	FKM	Flourinated Elastomer.
E	EPDM	Ethylene Propylene rubber.
K	FFKM	Perfluore Elastomer.

The configuration of the internal structure for magnetical pumps

table 4

Used materials	T	R	X
Rotating part	CARBON H.D.	CARBON H.D.	SiC
Fixed part	CER	SiC	SiC

- **T** Standard working conditions
- **R** Critical working conditions
- **X** Extreme working conditions



The mechanical seal for sealed pumps

table 5

CONDITION OF WORK	MODEL	TIPOLOGY	CODE
Standard	SF 1	single external, ptfе bellows	10
Standard	TS 5	single external, elastomer bellows	50
Extreme	BF 3	single internal, OR-ring	30
Critical	M.SF A	Double flushed, ptfе bellows	A0
Critical	M.TS C	Double flushed, elastomer bellows	C0
Hard	M.TS D	Double flushed, elastomer bellows	D0

table 6

EXECUTIONS	SF1	TS5	BF3	M.SF A	M.TS C	M.TS D
Rotating part	PTFE+V	CARB	SiC	PTFE+V	CARB	SiC
Fixed ring	CER	CER	SiC	CER	CER	CER
Bellows or OR *	PTFE	FKM	FKM	PTFE	FKM	FKM
2^ rotating part	-	-	-	CARB	CARB	CARB
2^ fixed ring	-	-	-	CER	CER	CER

* Elastomer in EPDM is used when necessary

SF 1

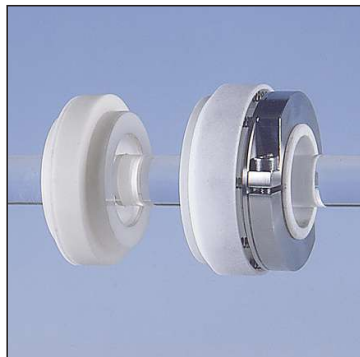

TS 5

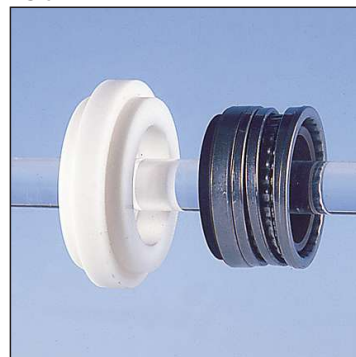

BF 3

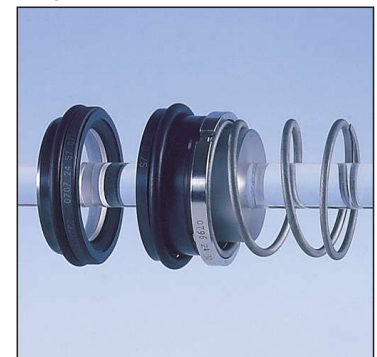

CURVES 50 HZ FOR ALL FRONTIERA MODELS

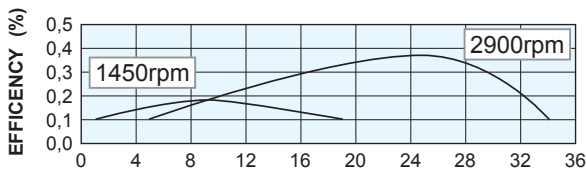
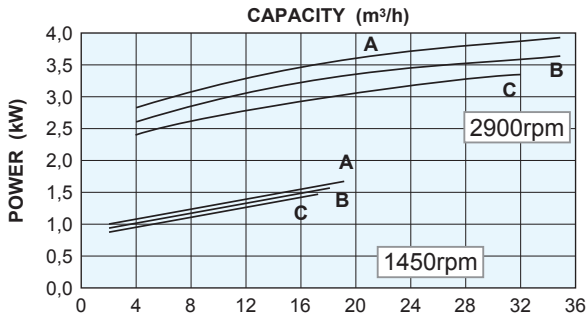
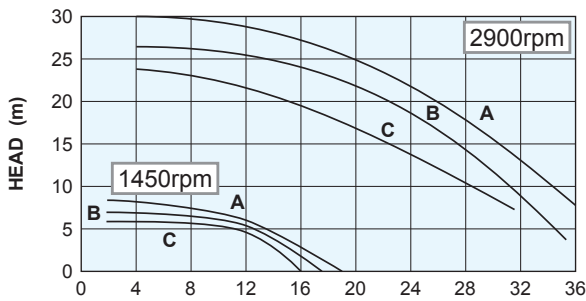

25/130

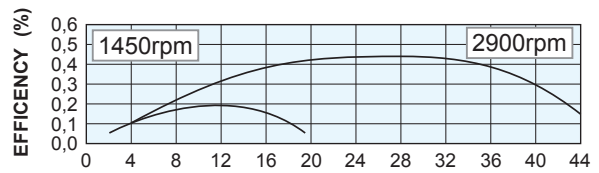
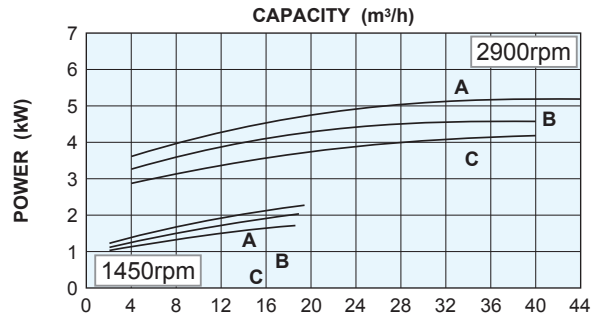
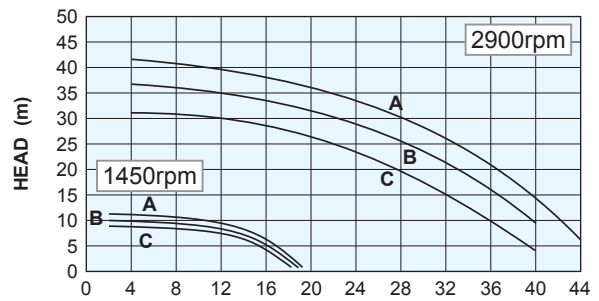

25/160

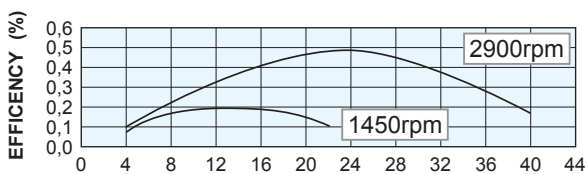
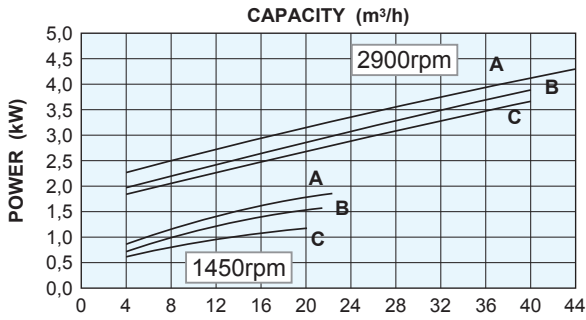
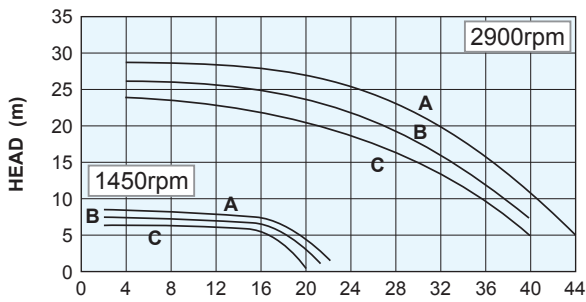

32/130

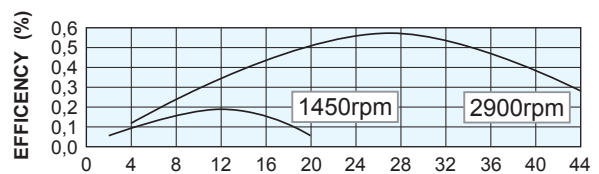
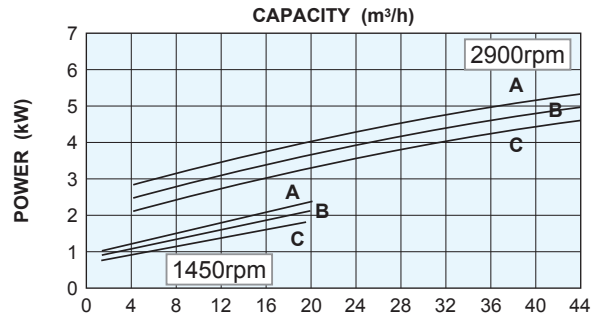
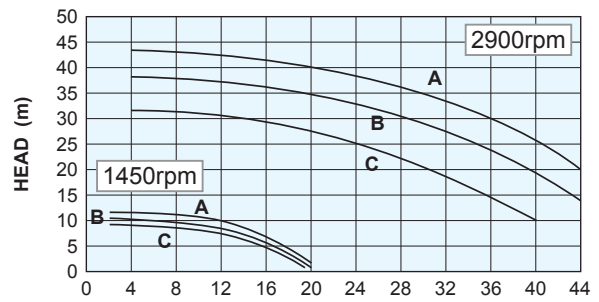

32/160

CURVES 50 AND 60 HZ FOR ALL FRONTIERA MODELS

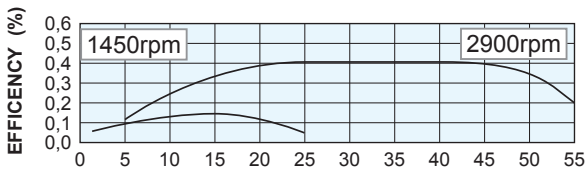
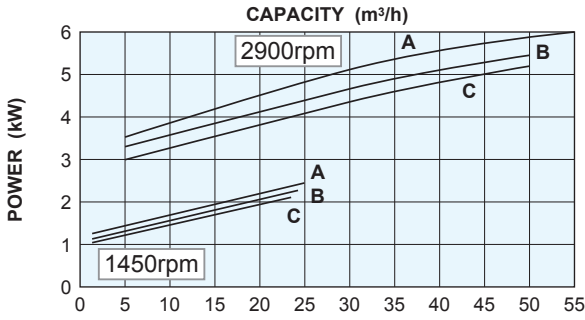
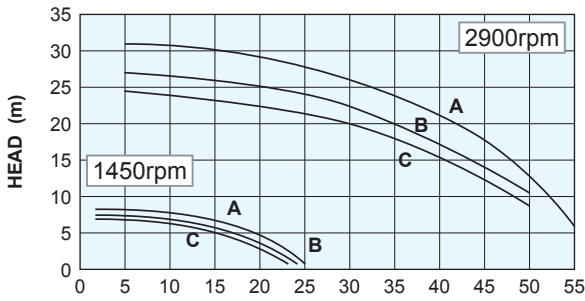

40/130

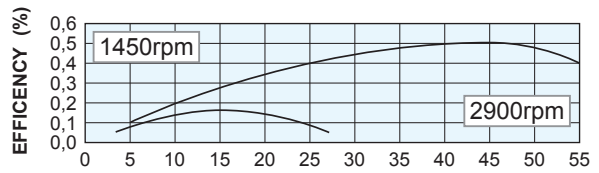
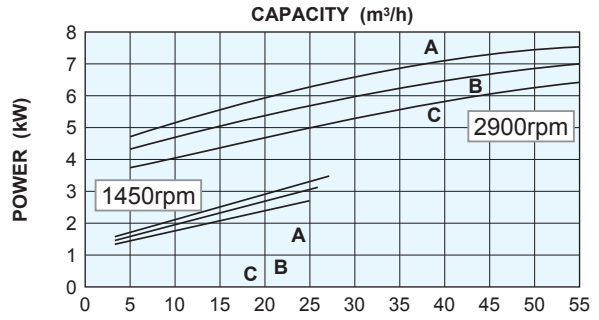
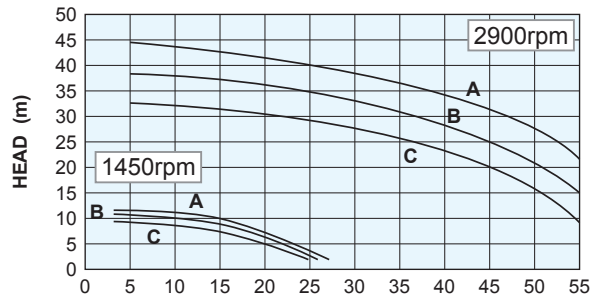

40/160

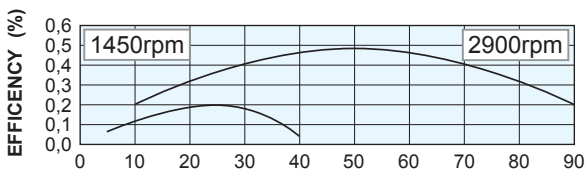
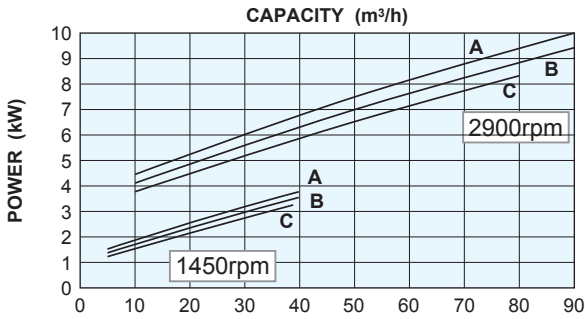
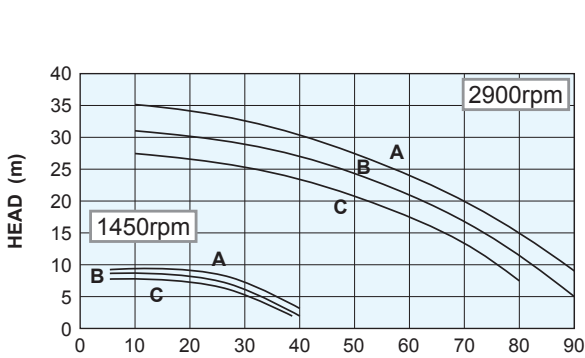

50/125

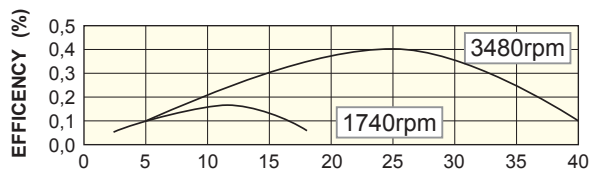
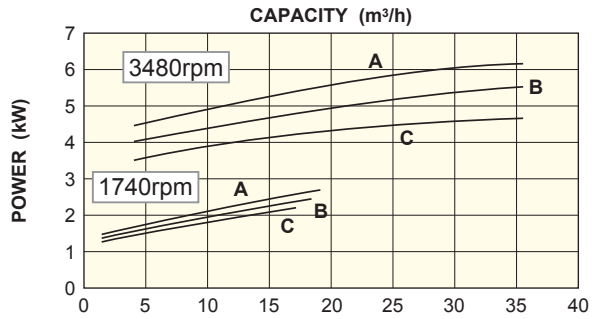
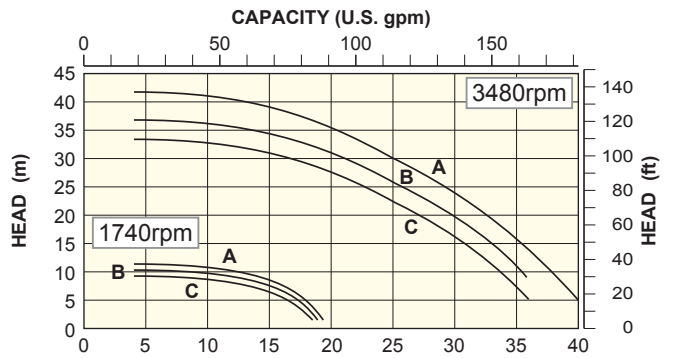

25/130

CURVES 60 HZ FOR ALL FRONTIERA MODELS

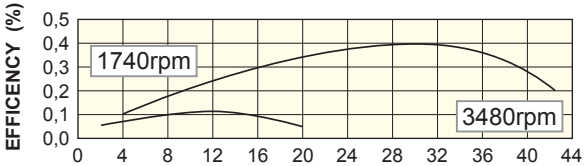
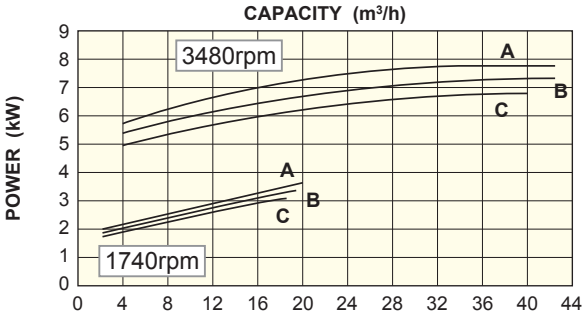
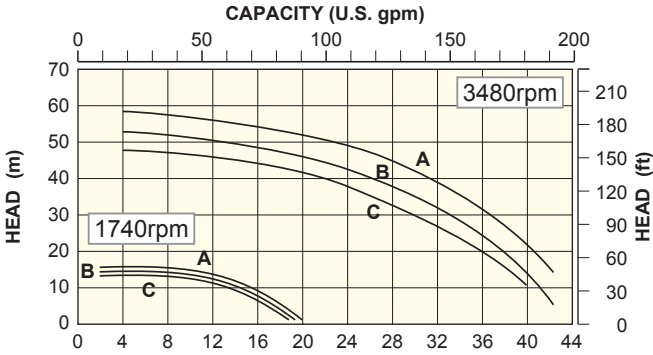

25/160

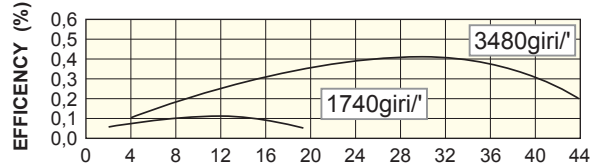
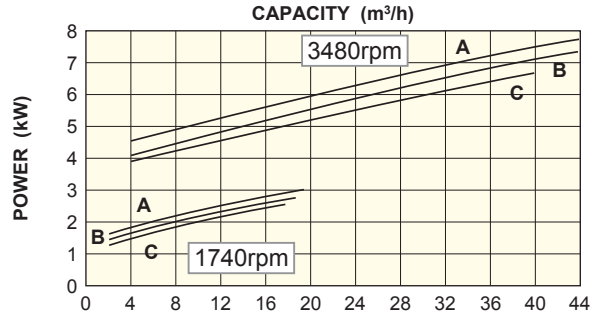
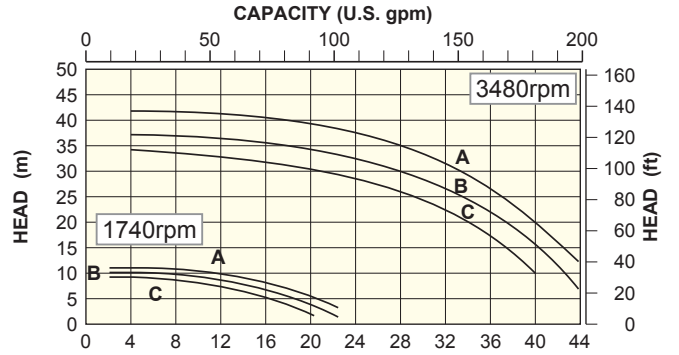

32/130

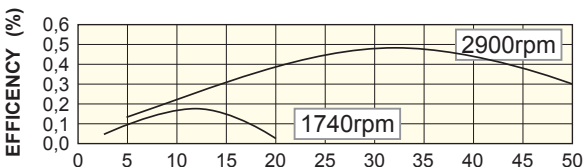
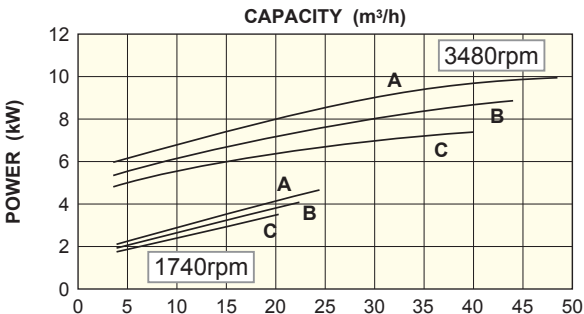
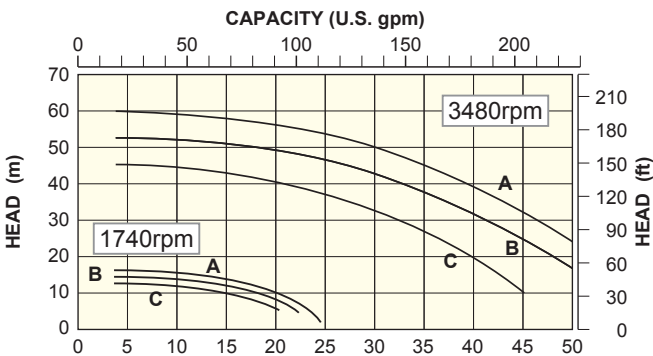

32/160

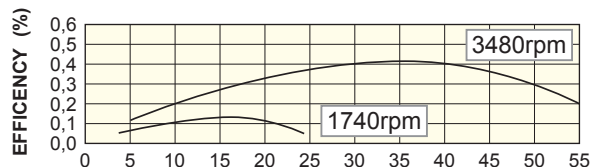
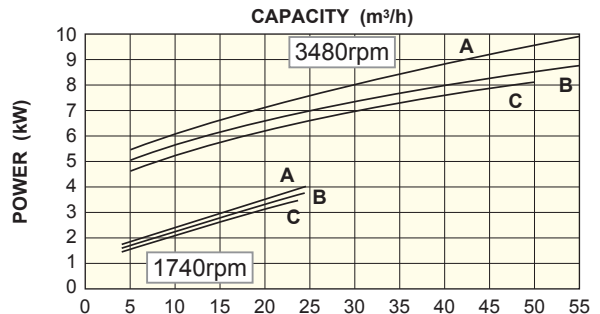
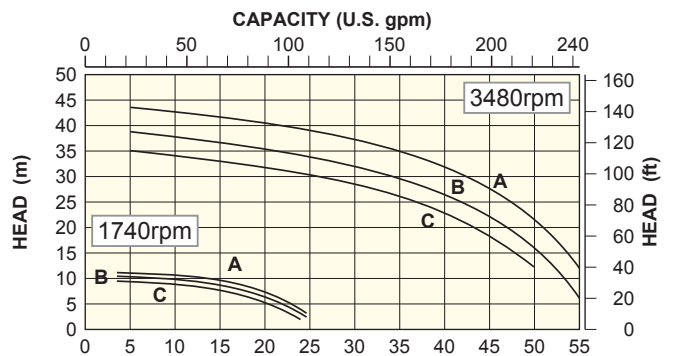

40/130

CURVES 60 HZ FOR ALL FRONTIERA MODELS

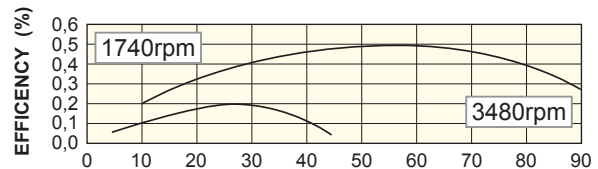
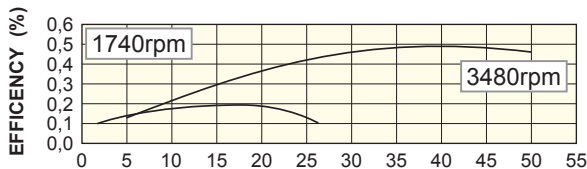
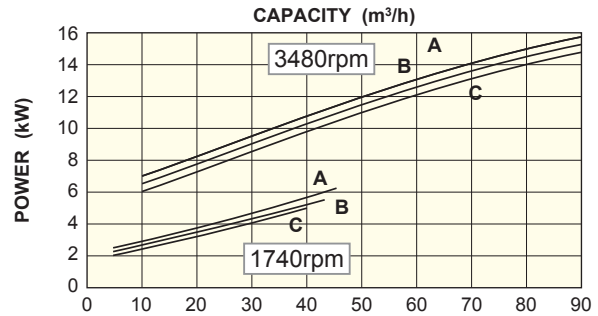
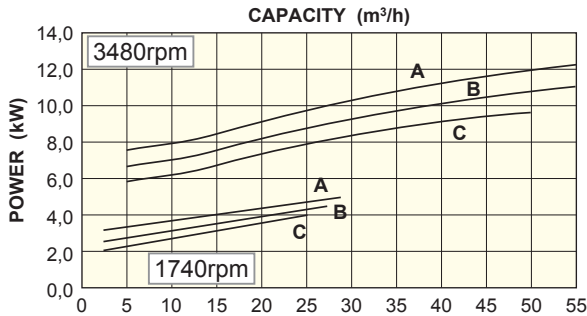
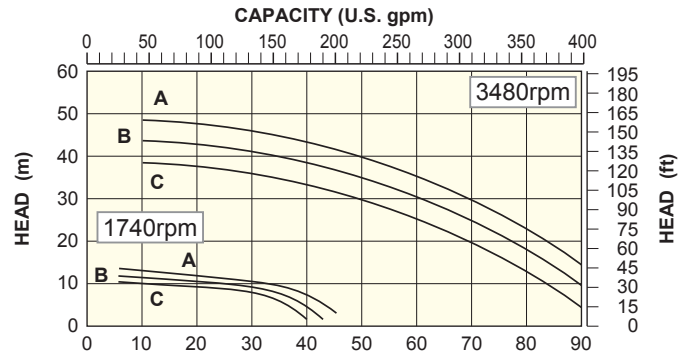
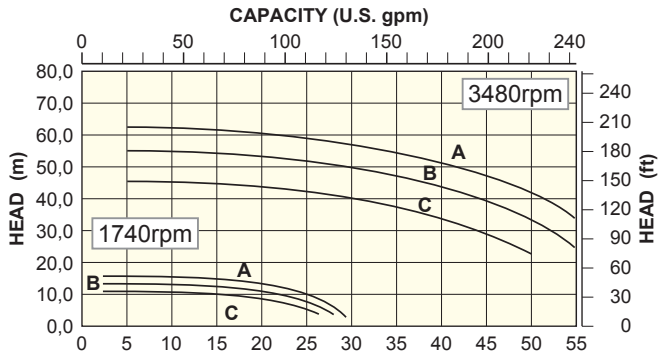

40/160

50/125

Notes for specific curves: Detailed curves for both 1450/1740 and 2900/3480 rpm give the performance curves for each available impeller diameter. These also give NPSHr, Efficiency and absorbed motor power. Liquid viscosities up to 30 cSt will not adversely affect pump performance. For hot liquids especially the NPSH (Net Positive Suction Head) must be considered. Suction pipework should be kept to a minimum, with as few bends/restrictions as possible. The suction pipe diameter should be at least that of the pump inlet, with the fluid velocity as low as is practical (max 2.5 m/sec.). If you have any problems ARGAL Customer Services will be pleased to advise. The curves performances are based on the following impeller diameter: • **A** max. diameter. For reducer performances are available: • **B** midd. diameter • **C** min. diameter.

Characteristics of IEC electric motors 2 poles

table 7

Model	Size	kW	Frame	Size	kW	Frame	Size	kW	Frame	Size	kW	Frame
25/130	112	4	B5	132	5,5	B35	132	7,58	B35	160	11÷15	B35
25/160												
32/130												
32/160												
40/130												
40/160												
50/125												

Motor protection system typology:

- **N** Motor standard voltage (400±10%)
- **S** Motor special voltage
- **E** Motor explosion proof

Characteristics of IEC electric motors 4 poles

table 8

Model	Size	kW	Frame	Size	kW	Frame	Size	kW	Frame	Size	kW	Frame	Size	kW	Frame	Size	kW	Frame
25/130	90	1,5	B5	100	2,2÷3	B5	100	3	B5	112	4	B5	132	5,5÷7,5	B5	160	11	B35
25/160																		
32/130																		
32/160																		
40/130																		
40/160																		
50/125																		

For TGF and ZGF (long-coupled) the motor frame is B3

DIMENSIONS

PUMPS DIMENSIONS - ZGF / TGF (long-coupled versions)

table 9

TGF - ZGF		Flanged connection ISO 2084 PN16-ANSI B 16.5								Dimensions														Base ref.		
Pump model	Motor size	Outlet				Inlet				Pump				Shaft			Assembly			Fixing				No		
		ND	k	l	z	ND	k	l	z	a1	f	h1	h2	d	c	x	a2	H	m2	n2	m1	n1	b		s1	w
25/130 25/160	80	32	100	M16	4	50	125	M16	4	80	385	132	160	24	50	100	60	237	70	190	100	240	50	14	285	N2
	90S																									N3
	90L																									N4
	100																									N5
	112																									
	160																									
32/130 32/160	80	32	100	M16	4	50	125	M16	4	80	385	132	160	24	50	100	60	237	70	190	100	240	50	14	285	N2
	90S																									N3
	90L																									N4
	100																									N5
	112																									
	160																									
40/130 40/160	80	40	110	M16	4	65	145	M16	4	80	385	132	160	24	50	100	60	237	70	190	100	240	50	14	285	N2
	90S																									N3
	90L																									N4
	100																									N5
	112																									
	160																									
50/125	80	50	125	M16	4	80	160	M16	8	80	385	132	160	24	50	100	60	237	70	190	100	240	50	14	285	N2
	90S																									N3
	90L																									N4
	100																									N5
	112																									
	160																									

Connections k also available as JIS rules

Bases dimensions

table 10

Base number	N2	N3	N4	N5
l1	800	900	1000	1120
b1, max	270	300	340	380
l2	130	150	170	190
l3	540	600	660	740
l4	35	35	40	40
b2	360	390	450	490
b3	320	350	400	450
h3, max	125	125	125	140
d1	19	19	24	24

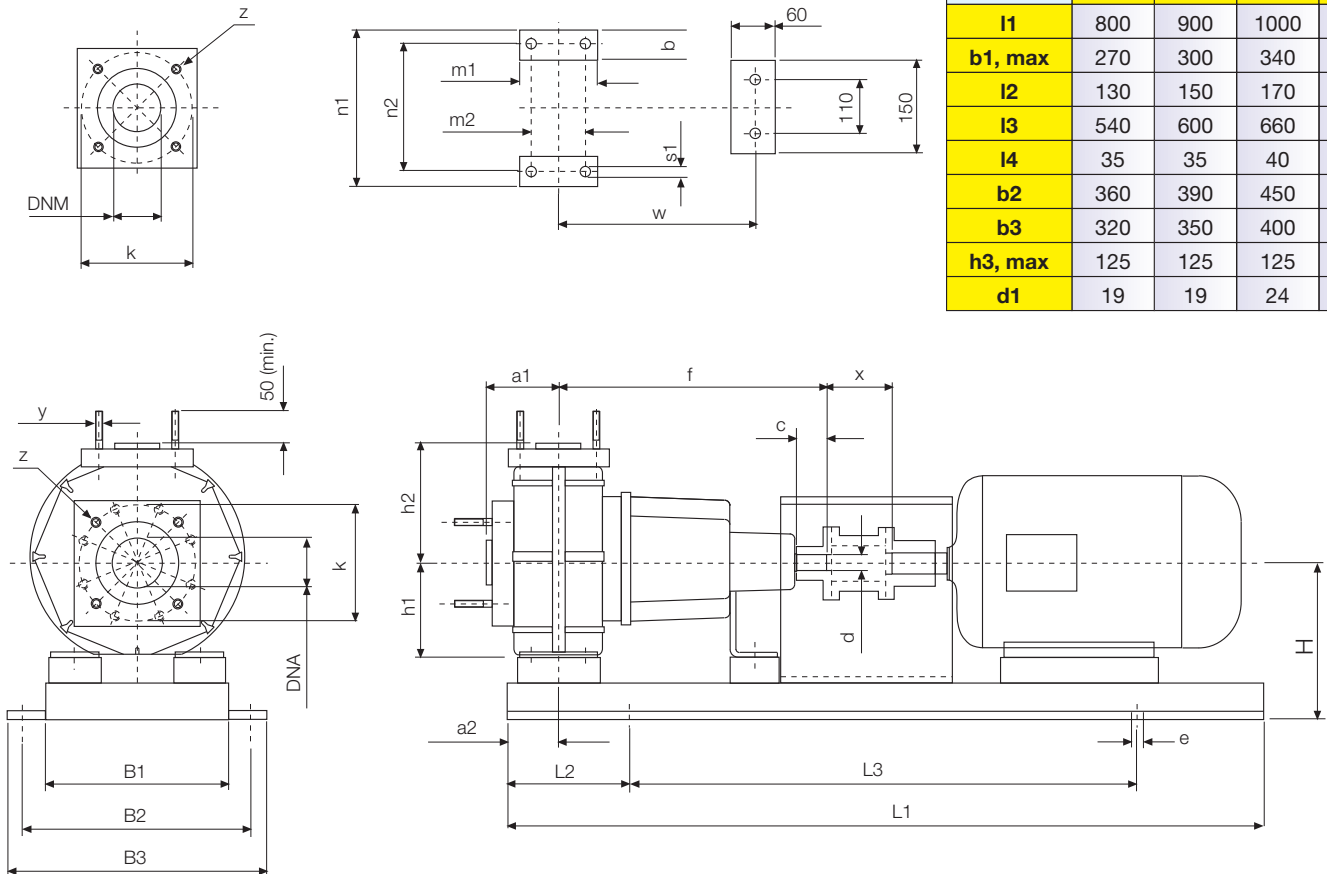

DIMENSIONS

DIMENSIONS TABLE PUMPS TMF / ZMF (close-coupling models)

table 11

TMF - ZMF		Flanged connection ISO 2084 PN16-ANSI B 16.5								Pump and motor dimensions								Dimensions										Pos. fixing ref.			
Pump model	Motor size	Outlet				Inlet				a1	f	h1	h2	em*	L*	Fixing x					Fixing y										
		ND	k	y	z	ND	k	y	z							ax	mx	nx	mx1	nx1	sx	qy	my	ny	my1	ny1	sy				
25/130 25/160	N	80	32	100	M16 ~ 5/8	4	50	125 ~ 121	M16 ~ 3/4	4	80	265	132	160	160	236 581	215	80	170	130	200	14	/	/	/	/	/	/	xS		
		90S-L										281																	626	xS	
		100										314																	669	xS	
		112										323																	678	xS	
		132										295																	360	735	xS+yM
		160										325																	495	900	xS+yM
	R	80	265	236	581	xP+yS																									
		90S-L	281	626	xP+yS																										
		100	314	669	xP+yS																										
		112	323	678	xP+yS																										
		132	295	360	735	xP+yM																									
		160	325	495	900	xP+yM																									
32/130 32/160	N	80	32	100	M16 ~ 5/8	4	50	125 ~ 121	M16 ~ 3/4	4	80	265	132	160	160	236 581	215	80	170	130	200	14	/	/	/	/	/	/	xS		
		90S-L										281																	626	xS	
		100										314																	669	xS	
		112										323																	678	xS	
		132										295																	360	735	xS+yM
		160										325																	495	900	xS+yM
	R	80	265	236	581	xP+yS																									
		90S-L	281	626	xP+yS																										
		100	314	669	xP+yS																										
		112	323	678	xP+yS																										
		132	295	360	735	xP+yM																									
		160	325	495	900	xP+yM																									
40/130 40/160	N	80	40	110	M16 ~ 5/8	4	65	145 ~ 140	M16 ~ 3/4	4	80	265	132	160	160	236 581	215	80	170	130	200	14	/	/	/	/	/	/	xS		
		90S-L										281																	626	xS	
		100										314																	669	xS	
		112										323																	678	xS	
		132										295																	360	735	xS+yM
		160										325																	495	900	xS+yM
	R	80	265	236	581	xP+yS																									
		90S-L	281	626	xP+yS																										
		100	314	669	xP+yS																										
		112	323	678	xP+yS																										
		132	295	360	735	xP+yM																									
		160	325	495	900	xP+yM																									
50/125	N	80	50	125	M16 ~ 3/4	4	80	160 ~ 152	M16 ~ 3/4	8	100	265	132	160	160	236 601	235	80	170	130	200	14	/	/	/	/	/	/	xS		
		90S-L										281																	646	xS	
		100										314																	689	xS	
		112										323																	698	xS	
		132										295																	360	755	xS+yM
		160										325																	495	920	xS+yM
	R	80	265	236	601	xP+yS																									
		90S-L	281	646	xP+yS																										
		100	314	689	xP+yS																										
		112	323	698	xP+yS																										
		132	295	360	755	xP+yM																									
		160	325	495	920	xP+yM																									

Connections k also available as JIS rules - *Dimensions for 2 poles motor

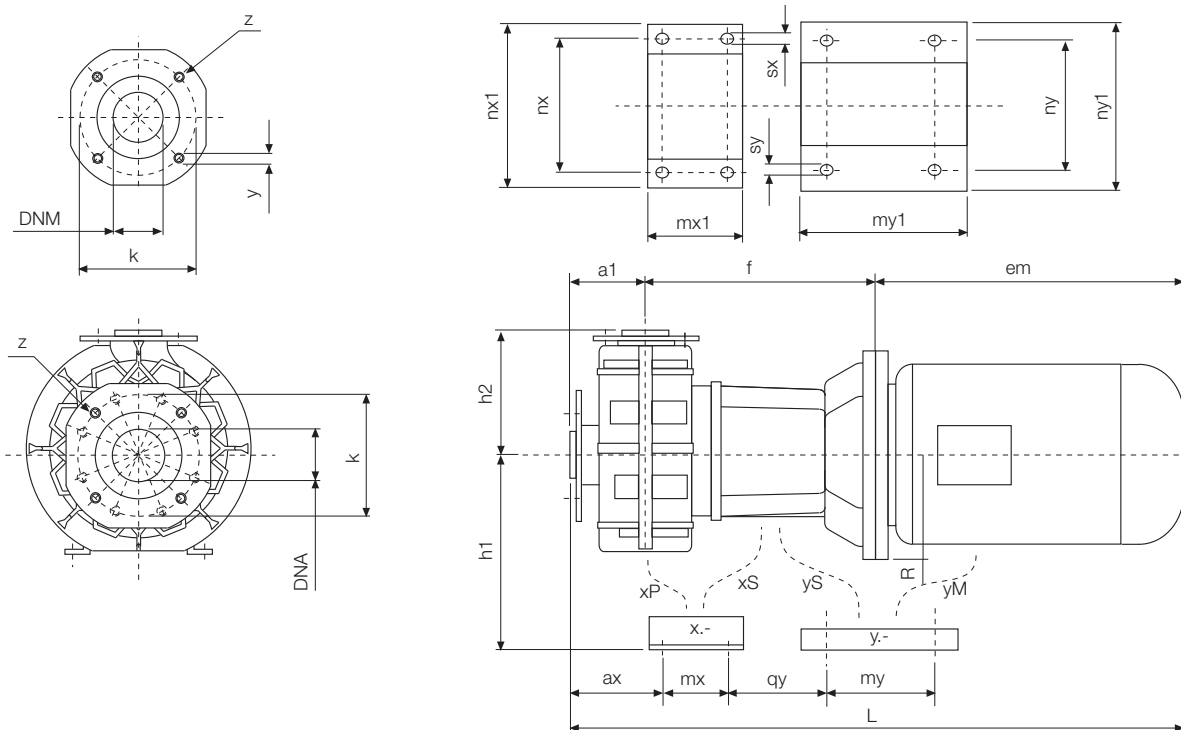

Chemical resistance of materials

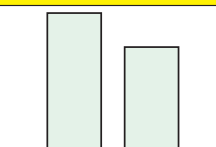
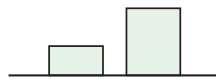
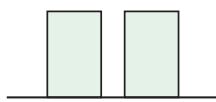

table 12

ELEMENTS OF VALUTATION	VERSIONS			
	WW - WX	GF - GX	V	K or P
MEDIUMS CHEMICAL:				
Cold mineral acids	++	++	+	+
Hot mineral acids	0	++	-	+
Cold oxidizing acids	-	++	+	+
Hot oxidizing acids	-	++	0/-	+
Cold inorganic salts	++	++	+	+
Hot inorganic salts	+	++	+	+
Cold inorganic bases	++	++	-(*)	+
Hot inorganic bases	++	++	-(*)	+
Cold alogens	-	+	+	+
Hot alogens	-	+	-	+
Cold aliphatic solvents	+	+	+	+
Hot aliphatic solvents	-	0	0/-	+
Cold aromatic solvents	-	+	0/-	+
Hot aromatic solvents	-	0	-	+
Cold functional aromatic solvents	-	+	-	+
Hot functional aromatic solvents	-	0	-	+
Cold chlorinated solvents	-	+	-	+
Hot chlorinated solvents	-	0	-	+
Cold alcohols	++	++	-(*)	+
Hot alcohols	+	+	-(*)	+
Cold ethers	-	+	-	+
Hot ethers	-	+	-	+
Cold ketones	+	+	-	+
Hot ketones	0	0	-(*)	+
Cold amines	+	++	-(*)	+
Cold polymer solvents	++	0	+	+
Field of admitted temperatures °C	0 ÷ +70	-30 ÷ +110	(*) use E = EPDM	
Abrasion resistance Mohs index	1÷3	3÷5		

Legend: Excellent ++ Good + Moderate 0 Not resistant -

Mechanical, thermal and chemical characteristics of the materials

table 13

Material characteristics	PP	E-CTFE
Mechanical: Structural (traction) (flection) Superficial (hardness) (abrasion)		
Thermal: Low temperatures High temperatures		
Chemical: Inorganic compounds Organic compounds		

The pump structure

table 14

FEATURES OF COUPLING EVALUATION	LONG-COUPLED G	CLOSE-COUPLED M
Conformity ISO 2858	Complete*	Only for the flanged connections
Pump dimensions	According to ISO 2858	Less than about 60%
Facilities for automatic check control	<ul style="list-style-type: none"> • Vibrations • Temperature • Losses 	<ul style="list-style-type: none"> • Losses • Wear
Maintenance	Planned services for mechanical structure and spares	Planned services only for spares
Working conditions	10-24 hours at day	Until 16 hours at day
Investment	Superior	Reduced

* Partial for models 25-32/130 — 25/160 — 40/130

table 15

FEATURES OF EVALUATION	ARMOURED R	INTEGRAL N
PN (nominal pressure of the pump) (Ref. H ₂ O at 20°C)	12 bar	8 bar
Presence of water hammer and/or over pressure	Good resistance	Middle resistance
External mechanical stress (e.g. loads on the hydraulic connections, accidental impacts)	Excellent resistance	Good resistance
Heat insulation	Y6 version (on request)	Not available

The need
of external armour

table 16

FEATURES OF EVALUATION	MECHANICAL DRIVEN PUMPS Z	MAGNETICAL DRIVEN PUMPS T
Hermetic structure	By mechanical seal	Total
EXAMINATION OF SOLIDS IN SUSPENSION General characteristics (to correlate)		
• Quantity in weight %	Applicable	Applicable if the general characteristics are close to the Minimum values
• Dimensions in mm.	Applicable	Not applicable
• Hardness in Mohs	Applicable	Not applicable
• Inclination to precipitate (crystallization, polymerization)	Applicable	Not applicable
• Sensitivity to the magnetic field	Applicable	Not applicable
Wear parts numbers	2	4+5
Maintenance	Normal	Simple
Viscosity (over 30cSt it is necessary to adjust the impeller dimension and the driving torque)	<250 cSt	<150 cSt

The rotation
transmission model

table 17

FEATURES OF EVALUATION	TYPE OF INTERNAL STRUCTURE		
	T	R	X
Concentrated acid compounds of flourine; strong concentrated hot alkali	Not applicable	Adequate	Applicable
Clean chemical mediums; hot/cold; concentrated/in solution	Adequate	Applicable	Applicable
Exam of suspended solids (to correlate):			
• Max. Quantity in weight %	3	5	5
• Max. Dimensions mm	0.5	0.5	0.5
• Max. Hardness index Mohs	2	2	6
Mediums which are inclined to produce gas when used	Not applicable	Adequate	Unadvised
Mediums with air in dispersion	Unadvised	Adequate	Applicable
Head > 40 m (50Hz) - 55 m (60Hz)	Applicable	Unadvised	Unadvised

The internal structure
of mag driven pumps

Sequence of the values in the appliability scale

-	~	+	++
Not applicable	Unadvised	Applicable	Adequate

The mechanical seals

table 18

EVALUATION FEATURES	SF1 - TS5	BF3	M.SE A - M.TS C	M.TS D
Concentrated acid compounds of flourine; strong concentrated hot alkali	Not Applicable	Applicable	Not Applicable	Not Applicable
Clean chemical mediums; hot/cold; concentrated/in solution	Adequate	Applicable	Applicable	Applicable
Mediums which are inclined to produce gas when are used	Adequate the SF1	Not Applicable	Applicable	Applicable
Exam of suspended solids (to correlate):				
• Max. Quantity in weight %	1÷3	1÷3 (a) - 1÷5 (b)	1÷11	1÷5 (a) - 1÷10 (b)
• Max. Dimensions mm	0.1÷0.6	0.1÷0,6 (a) - 1÷2 (b)	0.1÷0.8	0.1÷0.7 (a) - 0.1÷0.5 (b)
• Max. Hardness index Mohs	1÷2	3÷6	1÷2	3÷6
Mediums which are inclined to precipitate	Not Applicable	Applicable the BF3 only *	Adequate	Adequate

* With external flushing - **IMPORTANT:** See our chemical resistance tables and mechanical seal applications.

ACCESSORIES

By request the pumps are available with the following accessories:

- Y1 drain plug:all the models;
- Y2 Bearing temperature check control:only for long-coupled pumps (G);
- Y3 Dry running protection:all the models;
- Y4 Vibrations check control:all the models;
- Y5 Support loses ceck control:only for long-coupled pumps (G);
- Y6 Pump body heat insulation with expanded polyuretanic:only for armoured pumps;

PUMP IDENTIFICATION LABEL

table 21

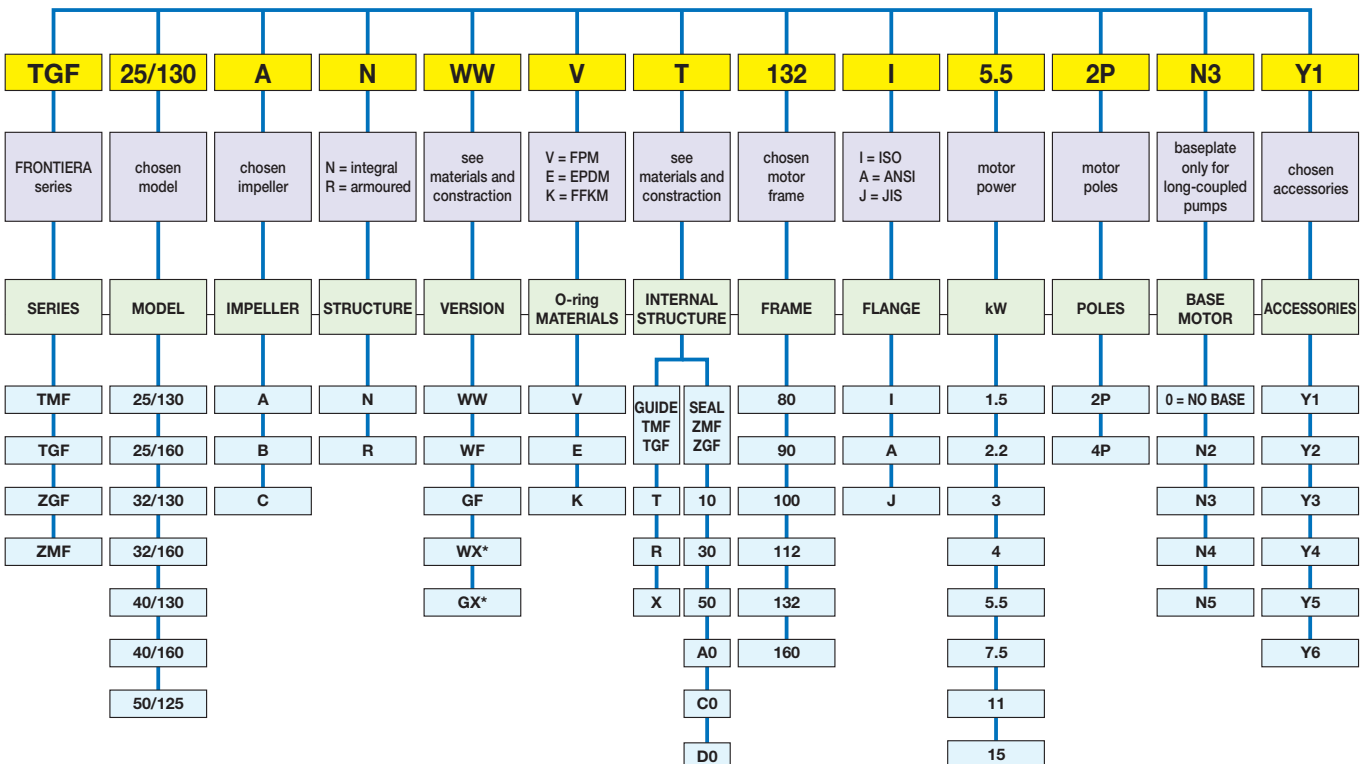

* For "ZMF" is not available

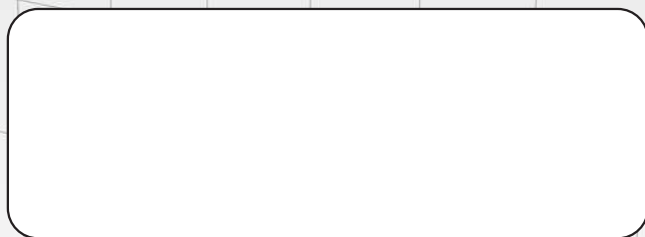

IT - 25125 BRESCIA - Via Labirinto, 159
Tel. +39 030 3507011 - Fax +39 030 3507077
Export dpt. Tel. +39 030 3507033
Web: www.argal.it - E-mail: export@argal.it

It is the policy of ARGAL to always improve its products and the right is reserved to alter specifications at any time without prior notice.
No part of this publication may be reproduced in any form or any means.