

ARGAL

CHEMICAL PUMPS

"K GK"
*chemical vertical
sump pumps*



*heavy duty construction
compact bearing support*

MAIN FEATURES

The KGK series Argal pumps are centrifugal and designed for vertical installations. They have column and volute casing submerged, own mechanical support and motor mounted above the liquid to be pumped. No metal part comes into contact with the fluid and not any bolts or nuts are submerged in the liquid. Under normal operating conditions, no mechanical sealing systems to prevent leaks of liquid are required while optional vapour seals are foreseen. Designed to pump corrosive chemicals have been engineered down to the smallest details to ensure long operating life and efficiency. Great care was paid to the KGK pumps right from the design board to ease maintenance and corrective operations for the repair crews internal or external to the companies served and for our worldwide net of distributors. The range of KGK pumps foresee three size ranges owing to different mechanical and hydraulic structure and the main parts subject to maintenance are the same for all the pumps belonging to each dimensional group.

CONSTRUCTION

These pumps are divided in two different constructive hydraulic typologies: sizes G1 and G2 that have impellers and single-stage volute casings working with centrifugal flows and size G3 that has impellers and bodies generating semi-axial flows and can be either at single-stage or double-stage with one or two impellers in series. For all the pumps the hydraulic axial inlet connection is downwards and fitted with protective filter; the outlet radial connection is joint to a vertical upward oriented discharge pipe to be connected to the hydraulic system, out of the tank, on the base plate. The support includes the rolling bearing and the elastic coupling and allow the central self-alignment of the normalized electrical motor. The lubrication of the bearing is by grease for G1 and G2 sizes and oil for G3 size. Columns available in standard lengths are from 500 to 4000 mm with increments of 250 mm.

MATERIALS

The materials wetted by the fluid pumped have excellent chemical resistance. The FC, WR and WF pump versions, completely constructed with thermoplastic or with column and delivery pipe made of FRP, and finished with the different guide and wear bushings specifications available, offer a wide combinations of chemically resistant execution materials. To select the proper configuration the concentration and temperature of the liquid pumped have to be compared with the maximum values admissible by the chemical compatibility charts provided by our technical department for the given liquid. This approach makes it possible to operate within the proper safety margins and ensure reliable applications.

GUIDE BUSHINGS

The material of the guide bushing and wear bushings located in the lower side of the pump close to the casing of the pump, are respectively glass reinforced PTFE and Al_2O_3 or alternatively, for solids or abrasive particles laden liquids, Silicon Carbide and Silicon Carbide. The bushings are lubricated by the liquid pumped, but, for mentioned solids or abrasive particles laden liquids is available an auxiliary external water flushing device.

VAPOUR SEAL SYSTEMS

To contain the vapours developing inside the pump in static and dynamic conditions a V ring dry vapour seal is located close to the base plate. On request is possible to add a dynamic deflector or a fluid barrier vapour system. It operates feeding modest quantities of compressed air or water with a push in rapid connector to build up a counter pressurised laminar flow and prevent vapours

or poisonous gases to flush the mechanical parts and escape in the environment.

MOTORS

The KGK pumps are equipped with electric motors fully compliant to IEC standards 400V +/- 5% voltage, multi frequency 50-60Hz frequency, tropicalised, IP 55 protection class F insulation, and B5 shape. Different degrees of protection and different voltages can be supplied on request. The 2-pole rotors have a rotating speed of 2900 rpm (50 Hz) and 3500 rpm (60Hz) and the 4-pole motors of 1450 rpm (50 Hz) and 1750 rpm (60Hz).

PAINTWORK

The support to host the pump shaft bearings and the electric motor flange (both of casted iron) are protected with epoxy enamel painted over an appropriate primer undercoat.

QUALITY

The single components as well as the complete pump are subjected to a quality control plan. For example we can certify on request composition and origin of the raw materials, balancing test, hydrostatic test. The functional test is executed accordingly to ISO 9906 Grade 2 – Annex 1 regulation. Our pumps comply with CE standards on machine safety and are supplied with all the relevant documentation. The installation use and maintenance manual must be carefully read and strictly followed by the user.

APPLICATIONS

Handling of acid, hydroxide and salt solutions in different concentrations and temperatures: mixture of strong acids, electrolytic baths, aromatic hydrocarbons, chlorides, alcohol, glycol ethers, emulsions, etc. from tanks, reservoirs and collection sumps. Liquids with a specific weight of up to 2 kg/dm^3 can be handled according to the installed power; maxim kinematics viscosity of 75 cSt and maxim temperature of 90°C to be reduced accordingly to the type of pump, type of material and length of the column as detailed in the table 4.



General Performance Curve 2900 r.p.m. - 50Hz

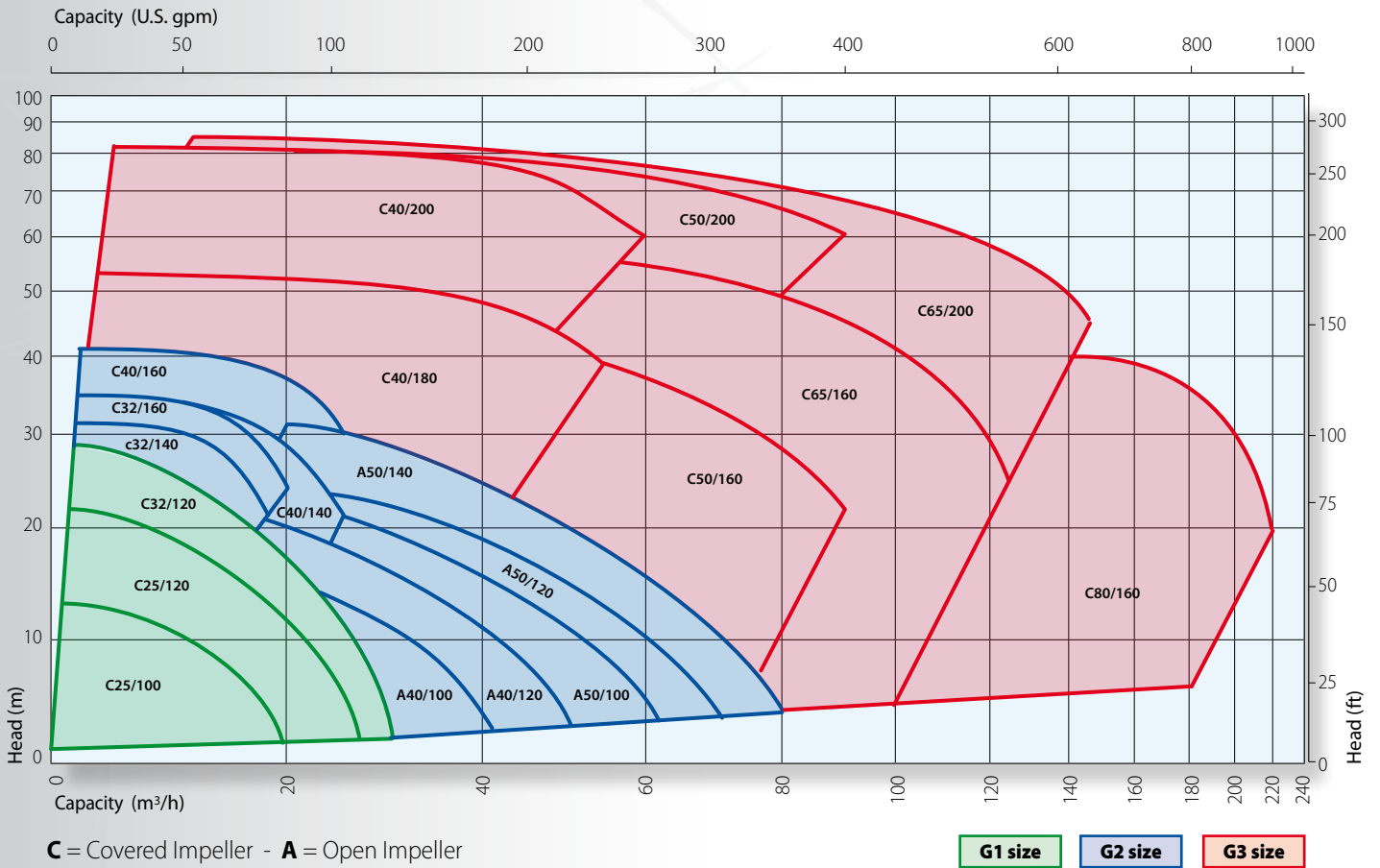

General Performance Curve 1450 r.p.m. - 50Hz

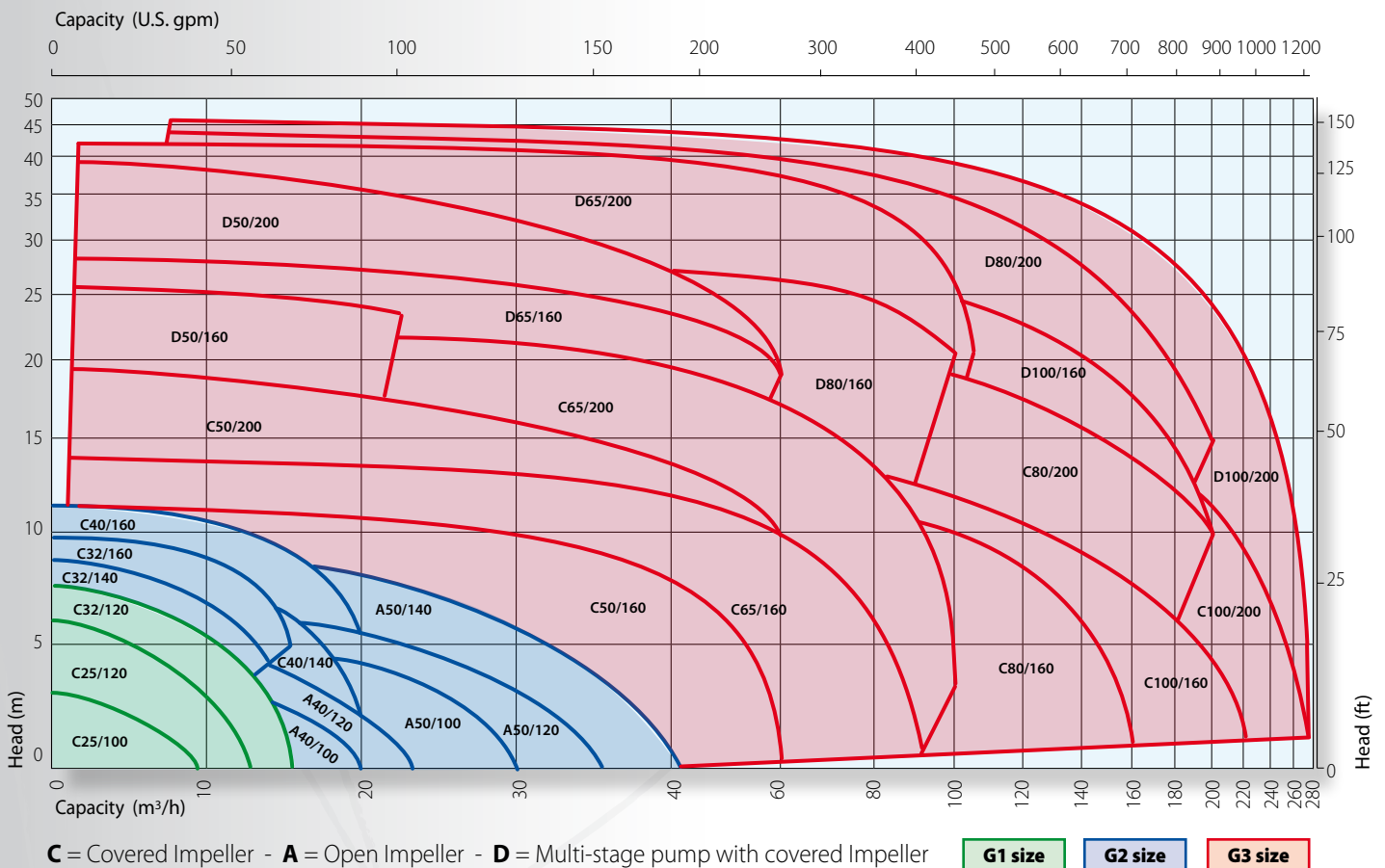

Note: All curves are referred to: water at 20°C - viscosity 1 °E - specific gravity 1 kg/dm³

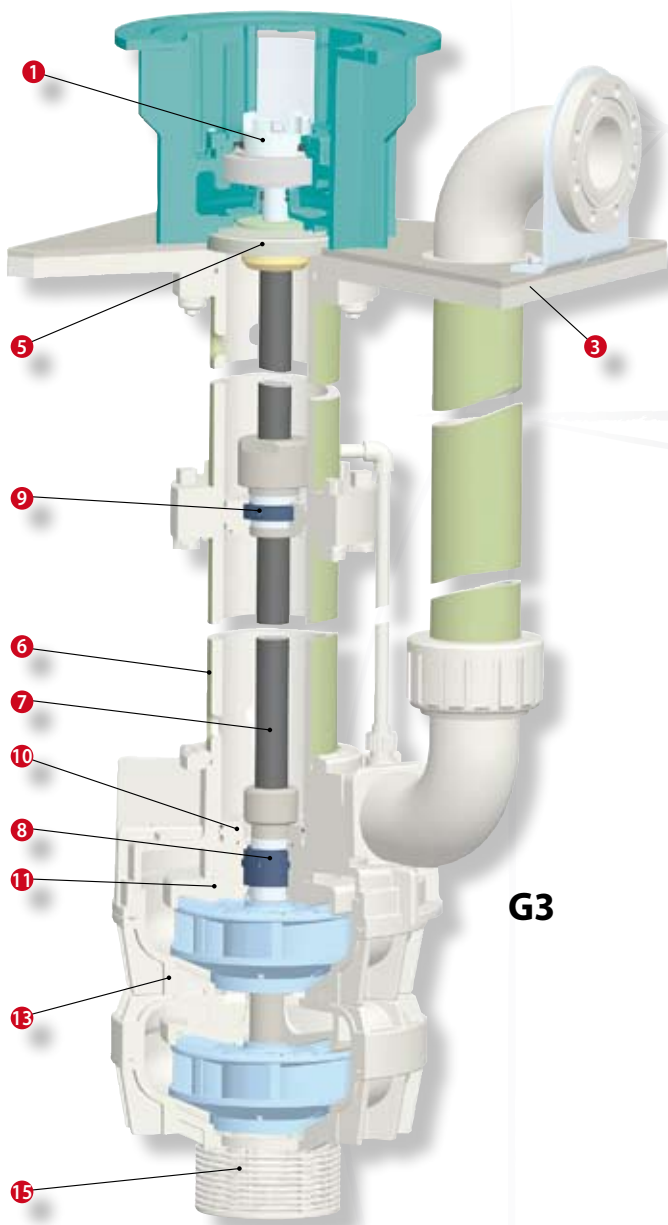

G3

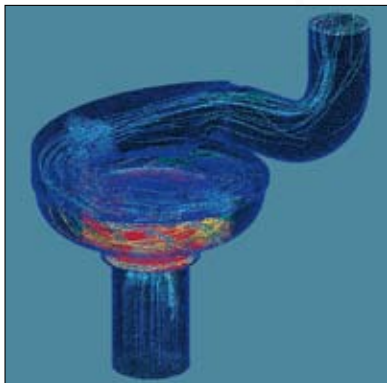

CFD
(Computing Fluid Dynamics)
analysis of semi axial flow
of the hydraulic parts

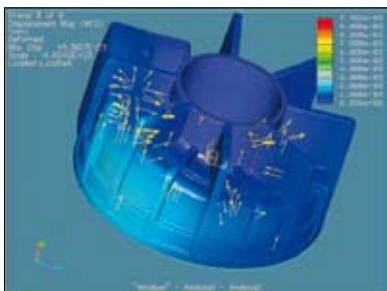

GEM
(Geometrical Elements Modelling)
analysis of Volute casing

MAIN COMPONENTS

- 1 Flexible coupling**
The flexible coupling with elastic joint allows neat and fast coupling and disassembling of the electric motor (IEC compliant) from the support while flanges with tolerances down to 1/10 of mm eliminate the need of any mechanical adjustment.
- 2 Bearing support**
The extremely compact vertical dimension of the support that hosts bearing and flexible joint simplifies and improves the deployment of the pump on tanks and plants, lowers the barycentre referred to the base plate, increases stability and minimises the oscillation whenever the frame to sustain the base plate of the pump is not adequately rigid.
- 3 Base plate**
Solid base in thermoplastic material or thermoplastic + metal for heaviest pumps.
- 4 Push in quick release fitting**
Push in quick release fitting to feed the "fluid barrier".
- 5 Vapour seal system**
VR - Static and dynamic (Standard). By an elastomeric ring operating dry contains pressure of 60 mbar in static and dynamic conditions.
VL - (Optional). By addition of a dynamic deflector counter pressures up to approximately 100 mbar .
VF - (Optional). Fluid barrier features a true active barrier to gas or vapours by mean of low pressure laminar flow of air fed from an external source.
VM - (Optional). Single mechanical seal lubricated with the pumped liquid.
- 6 Column and discharge pipe**
All wetted parts are made of plastic materials and the shaft is completely protected with a sleeve. In the version G the column and the delivery pipe are sheathed with polyester reinforced with glass fibres.
- 7 Pump shaft**
Pump shaft in steel covered with thermoplastic sheath.
- 8 Guide bushings**
Guide bushings with two different combinations of materials.
N - Glass fibres reinforced PTFE (GFR/ PTFE) on Ceramic alumina for generic applications.
X - Silicium carbide on Silicium carbide for liquids laden with high quantity of solids and / or abrasive particles in suspension.
- 9 Columns**
longer than 2000 mm deployed a further intermediate support guide with executed with same combination of materials.
- 10 Cartridge diaphragm**
Easy to replace Cartridge diaphragm guide bushing.
- 11 Positioning of the casing**
The pump casing is locked by a loose ring-nut. In case of replacement of the volute casing this floating locknut, allows simple and easy alignment o to the discharge pipe even after several years of operations. Thanks to this design the casing is locked without vulnerable bolts and nuts.
- 12 Pump casing with radial volute (G1-G2)**
The single stage pump volute casings are injection moulded, ribbed and with uniform and deep wall thickness. The polymers are reinforced for the best dimensional stability and mechanical resistance.
- 13 Pump casing with axial volute (G3)**
This execution can be configured either as single or dual stage (1 or 2 impellers) depending upon the performances or the application required. The conic centrifugal impeller generating semi axial flow delivers to the guide system reduced load and vibrations increasing the life cycle of the parts, reducing the overall LCC (life cycle cost) of the pump and its need of maintenance.
- 14 Flushing line for guide bushings**
Optional connection for the external flushing of the guide bushing with clean water when slurries are pumped.
- 15 Bottom filter**
A new bottom filter with 3 mm passages is available as integral component of the pump.

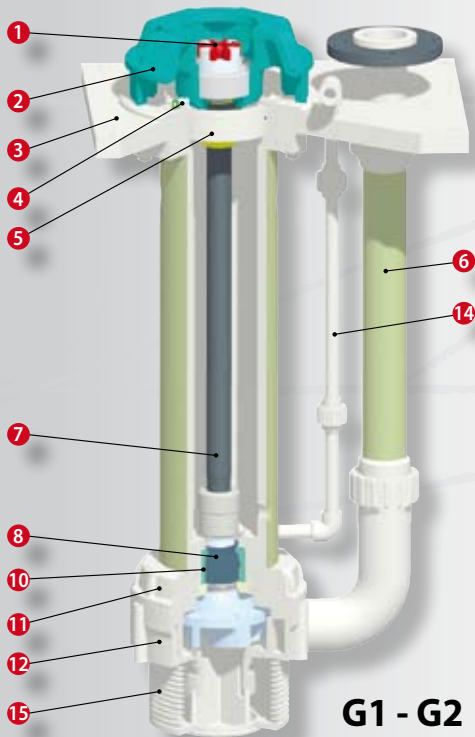

G1 - G2

MOTOR POWER INSTALLED (50 Hz)

table 1

kW	0.25	0.37	0.55	0.75	1.1	1.5	2.2	3	4	5,5	7,5	11	15	18,5	22	30	37	45	
C25/100	●	■	■	■	■	■	■	■	■	■	■	■	■	■	■	■	■	■	■
C25/120	■	■	■	■	■	■	■	■	■	■	■	■	■	■	■	■	■	■	■
C32/120	■	■	■	■	■	■	■	■	■	■	■	■	■	■	■	■	■	■	■
C32/140	■	■	■	■	■	■	■	■	■	■	■	■	■	■	■	■	■	■	■
C32/160	■	■	■	■	■	■	■	■	■	■	■	■	■	■	■	■	■	■	■
A40/100	■	■	■	■	■	■	■	■	■	■	■	■	■	■	■	■	■	■	■
A40/120	■	■	■	■	■	■	■	■	■	■	■	■	■	■	■	■	■	■	■
C40/140	■	■	■	■	■	■	■	■	■	■	■	■	■	■	■	■	■	■	■
C40/160	■	■	■	■	■	■	■	■	■	■	■	■	■	■	■	■	■	■	■
A50/100	■	■	■	■	■	■	■	■	■	■	■	■	■	■	■	■	■	■	■
A50/120	■	■	■	■	■	■	■	■	■	■	■	■	■	■	■	■	■	■	■
A50/140	■	■	■	■	■	■	■	■	■	■	■	■	■	■	■	■	■	■	■
C40/180	■	■	■	■	■	■	■	■	■	■	■	■	■	■	■	■	■	■	■
C40/200	■	■	■	■	■	■	■	■	■	■	■	■	■	■	■	■	■	■	■
C50/160	■	■	■	■	■	■	■	■	■	■	■	■	■	■	■	■	■	■	■
D50/160	■	■	■	■	■	■	■	■	■	■	■	■	■	■	■	■	■	■	■
C50/200	■	■	■	■	■	■	■	■	■	■	■	■	■	■	■	■	■	■	■
D50/200	■	■	■	■	■	■	■	■	■	■	■	■	■	■	■	■	■	■	■
D50/160	■	■	■	■	■	■	■	■	■	■	■	■	■	■	■	■	■	■	■
C65/160	■	■	■	■	■	■	■	■	■	■	■	■	■	■	■	■	■	■	■
D65/160	■	■	■	■	■	■	■	■	■	■	■	■	■	■	■	■	■	■	■
C65/200	■	■	■	■	■	■	■	■	■	■	■	■	■	■	■	■	■	■	■
D65/200	■	■	■	■	■	■	■	■	■	■	■	■	■	■	■	■	■	■	■
C80/160	■	■	■	■	■	■	■	■	■	■	■	■	■	■	■	■	■	■	■
D80/160	■	■	■	■	■	■	■	■	■	■	■	■	■	■	■	■	■	■	■
C80/200	■	■	■	■	■	■	■	■	■	■	■	■	■	■	■	■	■	■	■
D80/200	■	■	■	■	■	■	■	■	■	■	■	■	■	■	■	■	■	■	■
C100/160	■	■	■	■	■	■	■	■	■	■	■	■	■	■	■	■	■	■	■
D100/160	■	■	■	■	■	■	■	■	■	■	■	■	■	■	■	■	■	■	■
C100/200	■	■	■	■	■	■	■	■	■	■	■	■	■	■	■	■	■	■	■
D100/200	■	■	■	■	■	■	■	■	■	■	■	■	■	■	■	■	■	■	■

■ IEC motor 2 poles ■ IEC motor 4 poles ● Motor for specific weight 1,1 Kg/dm³ at full capacity with max impeller size

STANDARD PUMP LENGTHS (mm)

table 2

mm.	500*	750	1000	1250	1500	1750	2000	2250	2500	2750	3000	3250	3500	3750	4000
WR - WF - FC															
WRG - WFG - FCG															

(*) dimension not available for "D" models

Submerged rotating parts

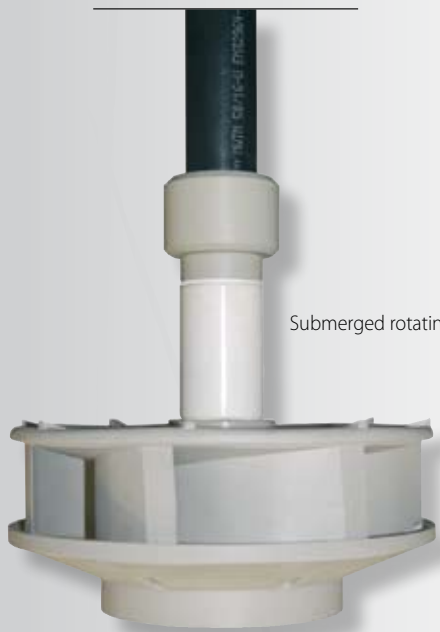

Pump casing with axial volute and conic centrifugal covered impeller

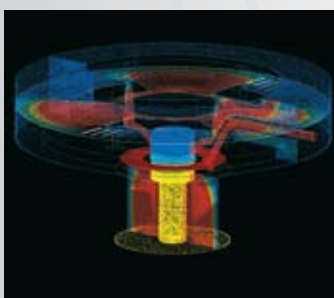

CFD
(Computing Fluid Dynamics)
analysis of the air flow
within fluid barrier system

THE EXECUTIONS

FC – FCG

The base resin is PVDF (vinylidene polyfluoride): it's a fluorinated polymer resistant to abrasion, and with high degree of mechanical resistance. The addition of carbon fibres increases its mechanical properties and dimensional stability without reducing its chemical resistance.

WR – WRG

The base resin is PP (polypropylene); characterised by chemical resistance to a large range of chemicals and reinforced with glass fibres offers good mechanical resistance and dimensional stability.

WF - WFG

The base resin is PP reinforced with glass fibers, while the stressed mechanical parts are made of PVDF to increase resistance to wear and abrasion.

Note:

The G versions have the submerged column and the discharge pipe sheathed with FRP (Fiber reinforced polyester). This reduces the extension of column and discharge pipe consequent to variation of environmental and liquid temperature.

THE MATERIAL

table 3

Version	WR	WF	FC	WRG	WFG	FCG
Volute casing	GFR/PP	GFR/PP	CFF/PVDF	GFR/PP	GFR/PP	CFF/PVDF
Impeller	GFR/PP	CFF/PVDF	CFF/PVDF	GFR/PP	CFF/PVDF	CFF/PVDF
Shaft coating	PE	PE	PTFE	PE	PE	PTFE
Baseplate	PP	PP	PP	PP	PP	PP
Submerged column	PP	PP	PVDF	PP/FRP	PP/FRP	PVDF/FRP
Discharge stub pipe	PP	PP	PVDF	PP/FRP	PP/FRP	PVDF/FRP
Support	CAST IRON					
Gasket	FKM / EPDM					
Screws	STAINLESS STEEL					

GFR/PP	Glass fibre reinforced Polypropylene
CFF/PVDF	Vinylidene polyfluoride carbon fibre filled
PP	Polypropylene
PVDF	Vinylidene polyfluoride
PE	Polyethylene
PTFE	Polytetrafluoroethylene
PP/FRP	PP column sheathed with glass fiber reinforced polyester vinylester resin
PVC/FRP	PVC column sheathed with glass fiber reinforced polyester vinylester resin
PVDF/FRP	PVDF column sheathed with glass fiber reinforced polyester vinylester resin
FKM	Fluorine rubber
EPDM	Ethylene-Propylene rubber



TECHNICAL DATA

table 4

Under plate lenght (mm)	Max work temperature (°C)									
	500	750	1000	1250	1500	1750	2000	2500	3000	4000
Version										
WR / WF	70	65	55	50	45	40	35	30	n.a.	
FC	90	85	75	65	60	55	45	40	n.a.	
WRG	70									
WFG	75									
FCG	80									
Admitted environmental temperature range (°C)										
WR / WF	0 ÷ +40						+5 ÷ +40		n.a.	
FC	-10 ÷ +40			-0 ÷ +40			+5 ÷ +40		n.a.	
WRG/WFG	0 ÷ +40						+5 ÷ +40			
FCG	-10 ÷ +40			0 ÷ +40			+5 ÷ +40			

PUMP IDENTIFICATION LABEL

table 5

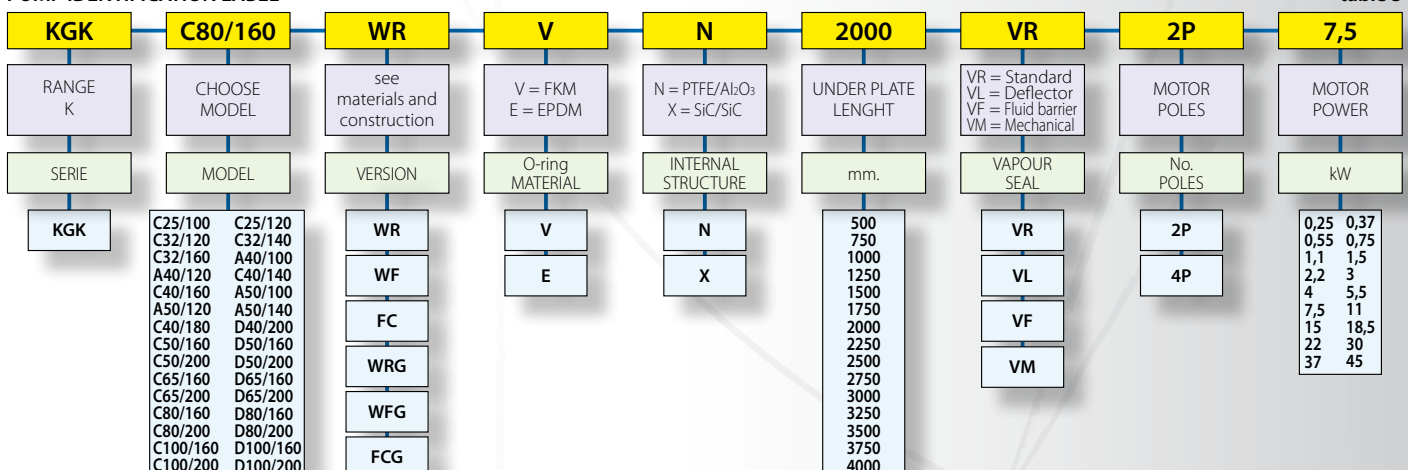

● 2900 r.p.m. - 50Hz

● 1450 r.p.m. - 50Hz

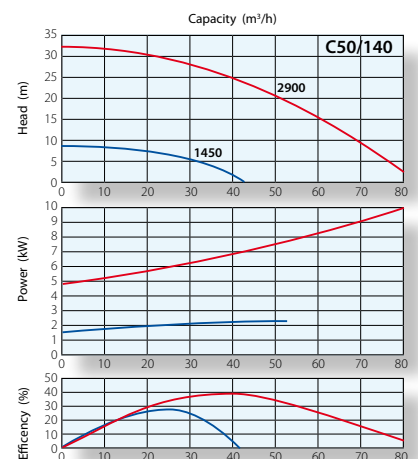
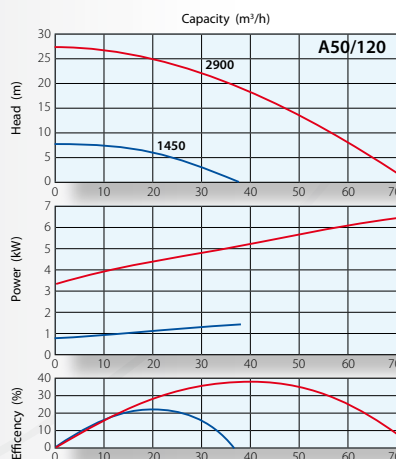
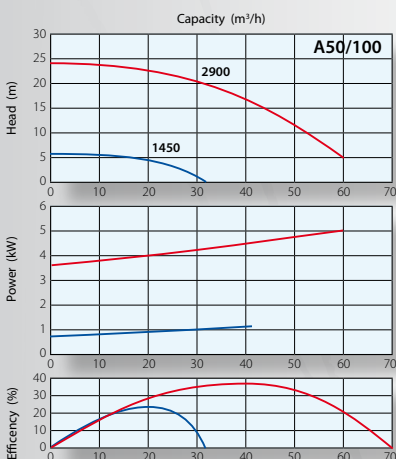
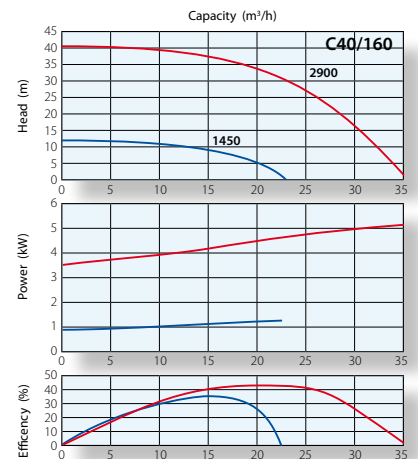
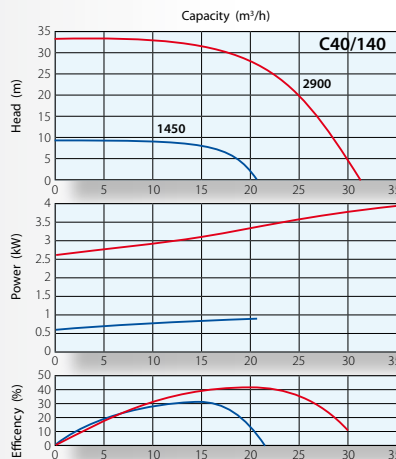
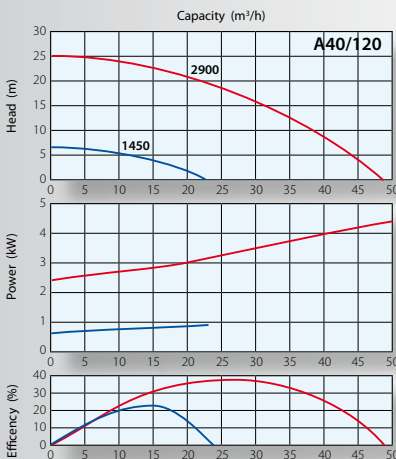
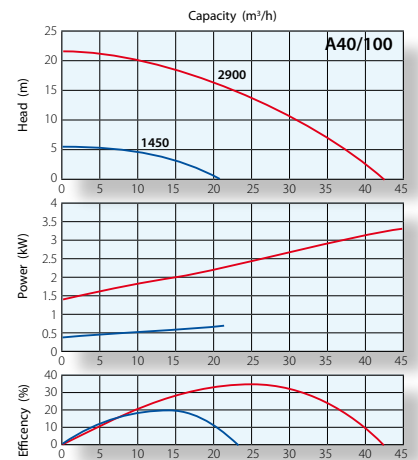
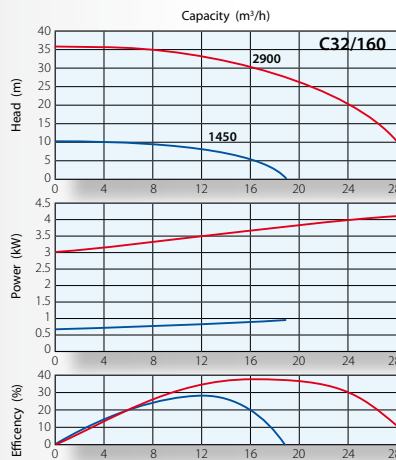
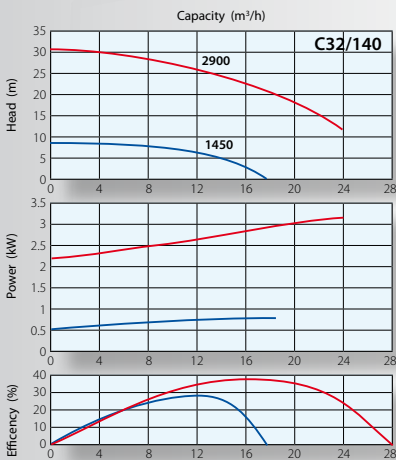
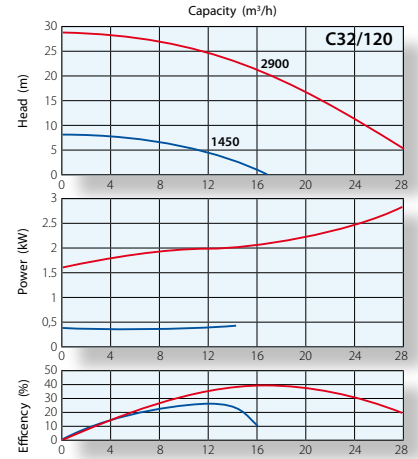
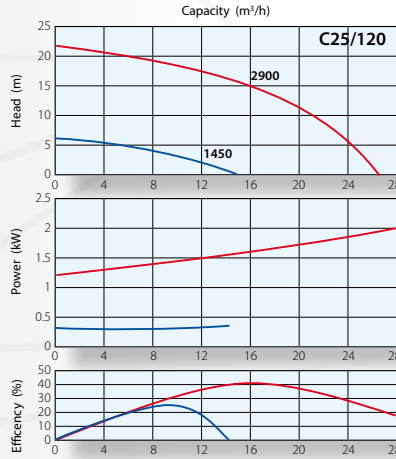
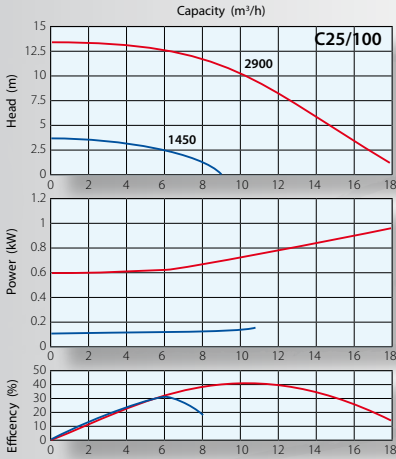

● 2900 r.p.m. - 50Hz

● 1450 r.p.m. - 50Hz

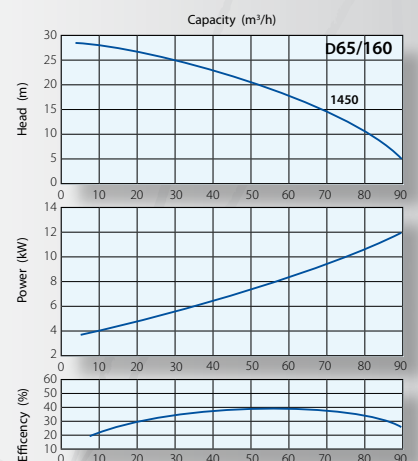
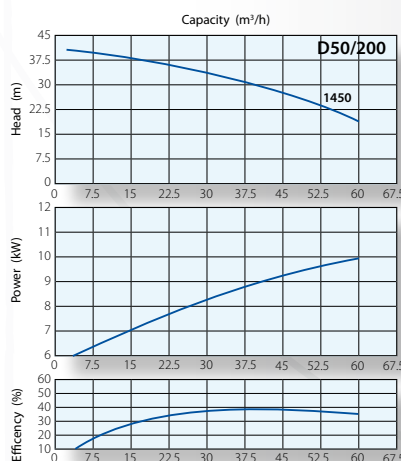
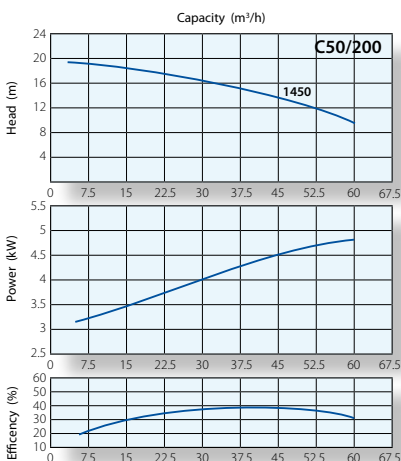
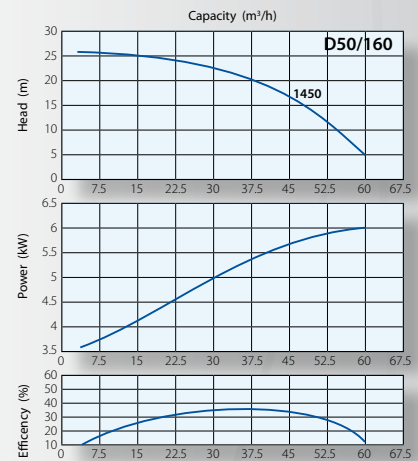
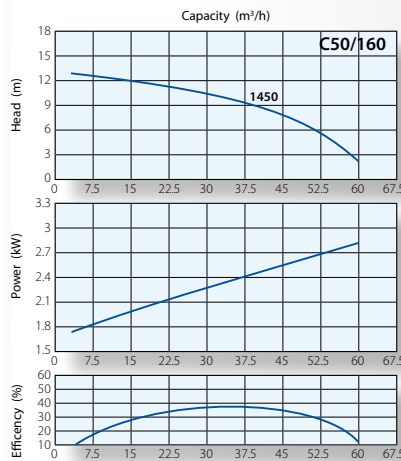
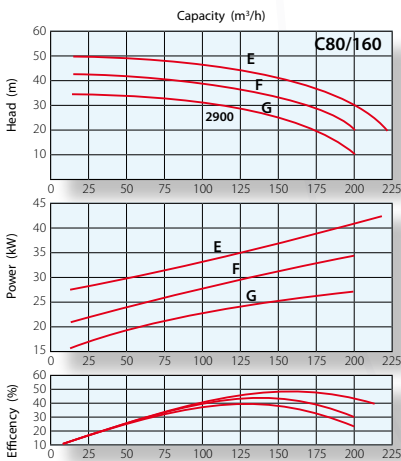
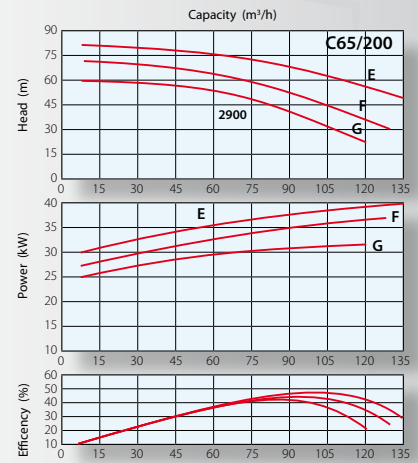
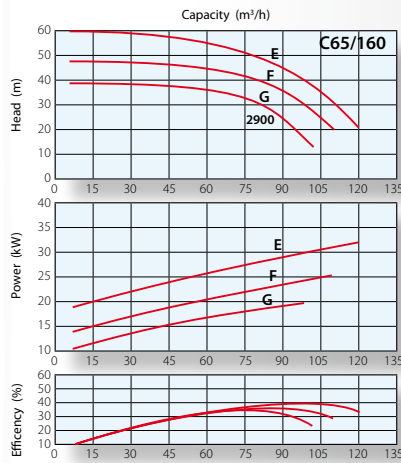
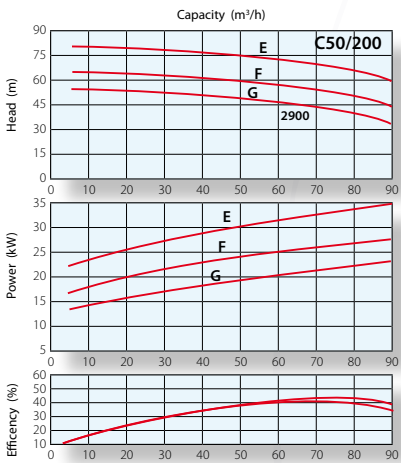
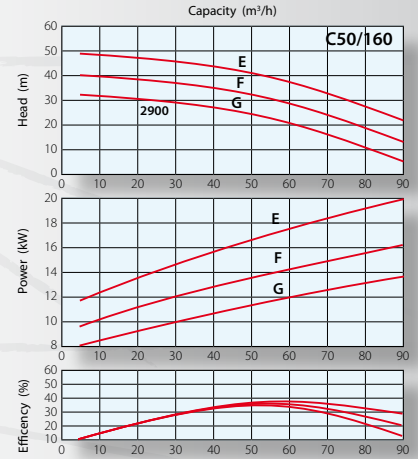
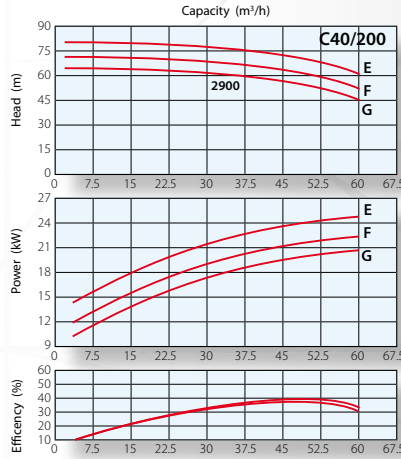
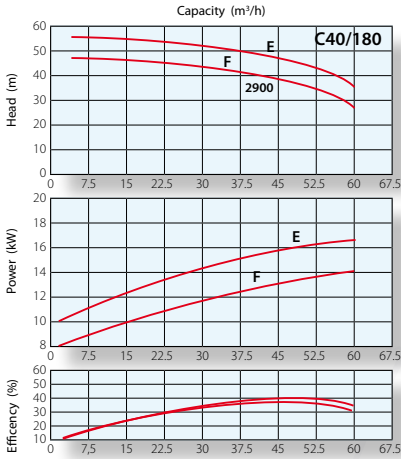

● 2900 r.p.m. - 50Hz

● 1450 r.p.m. - 50Hz

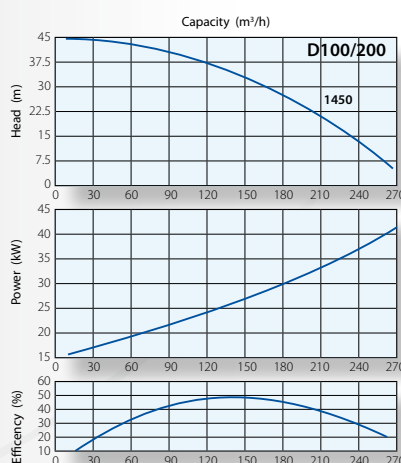
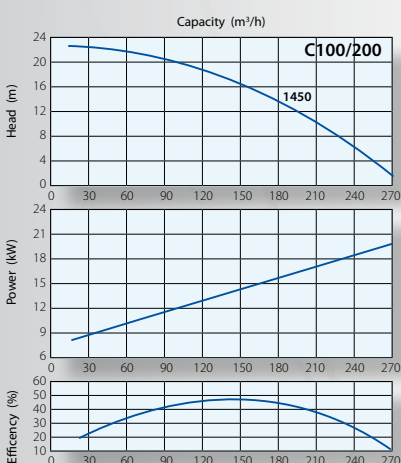
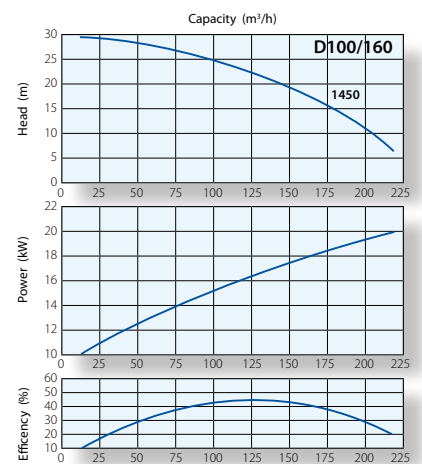
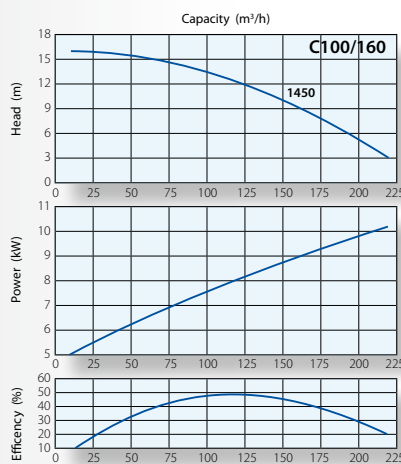
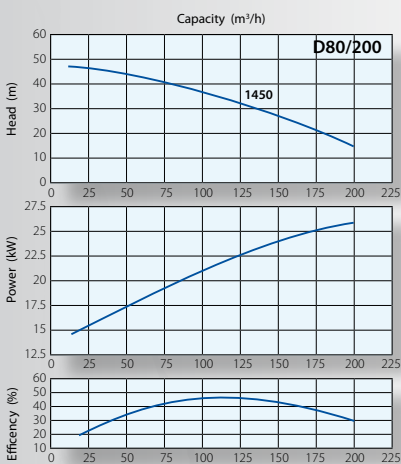
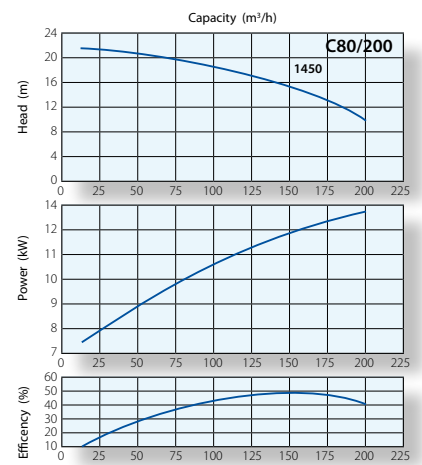
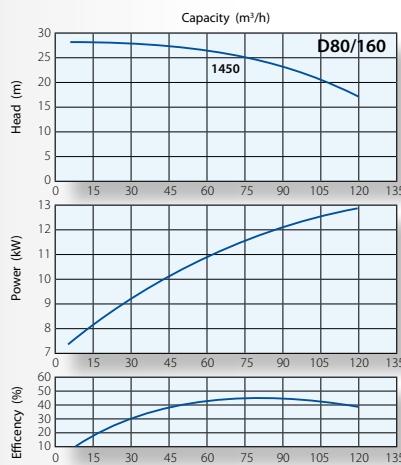
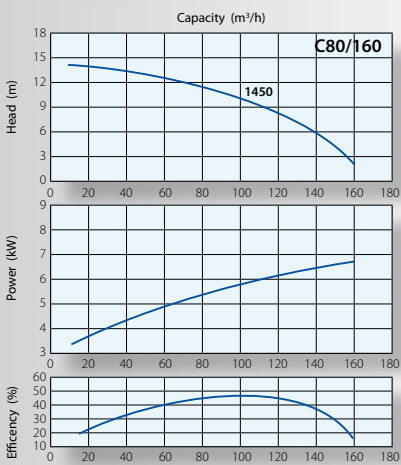
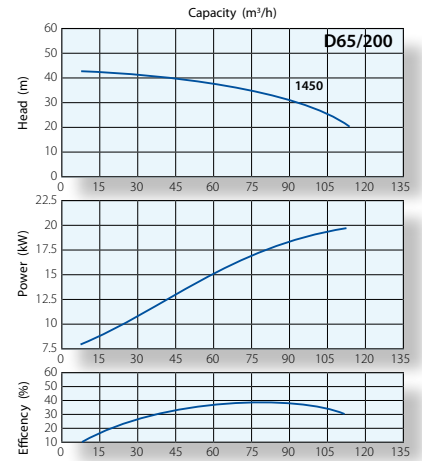
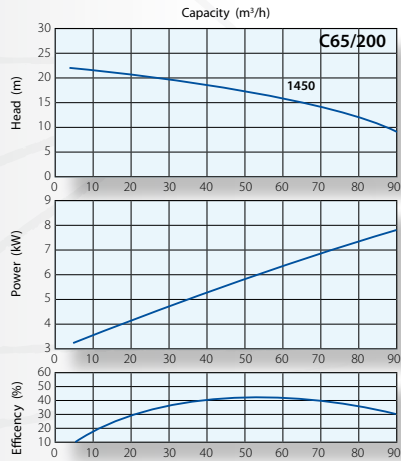
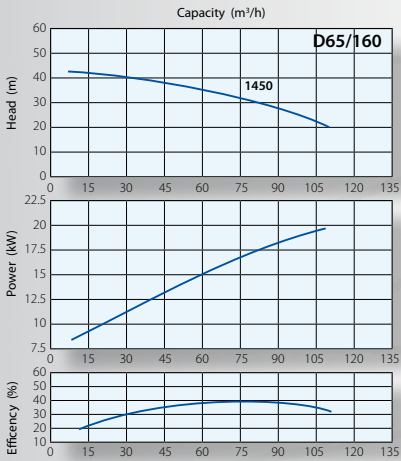

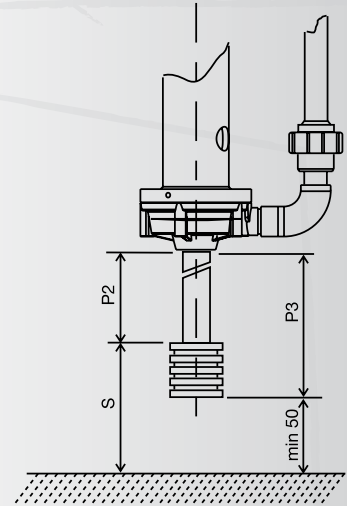
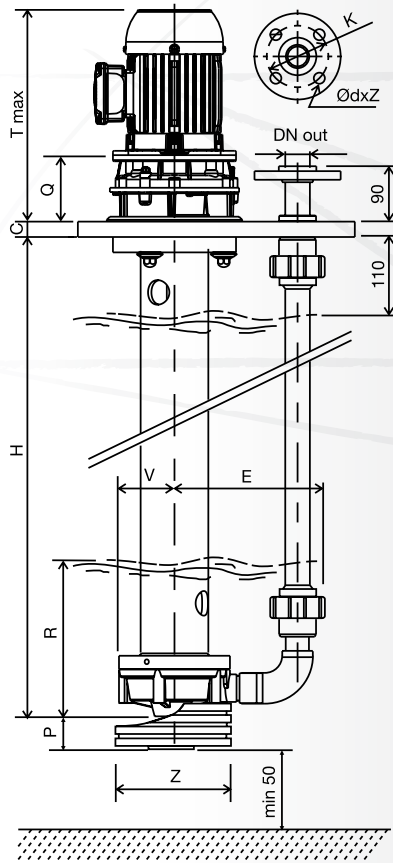
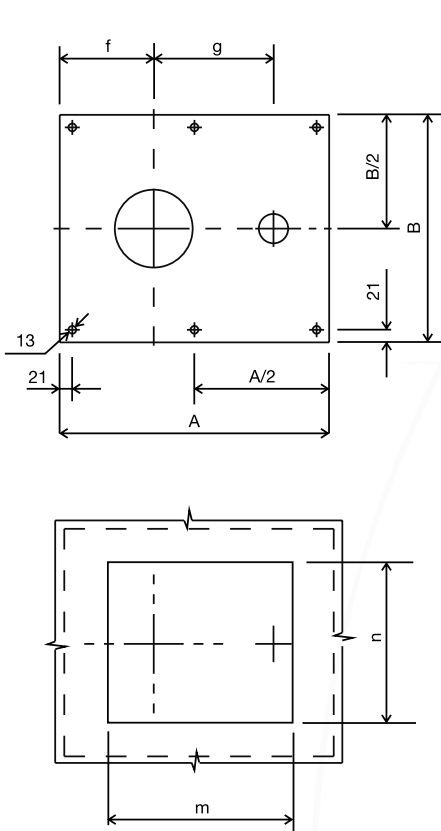

DIMENSIONS

table 6

MOD.	ND in	thread in	ND out	k	Ø dxz	Q max	V	E	R min	S min	P	P2 max(*)	P3 max(*)	Z	A	B	C	f	g	m	n	T min
C25/100	40	1 1/2"	25	85	14x4	120	93	240	130	50	40	2000	1000	200	450	380	25	157	200	345	260	410
C25/120	40	1 1/2"	25	85	14x4	135	111	240	130	50	40	2000	1000	200	450	380	25	157	200	345	260	470
C32/120	50	2"	32	100	18x4	135	111	240	130	60	45	2000	1000	200	450	380	25	157	200	345	260	470
C32/140	50	2"	32	100	18x4	191	125	275	250	60	50	2000	1000	200	530	400	30	185	235	420	280	700
C32/160	50	2"	32	100	18x4	191	125	275	250	60	50	2000	1000	200	530	400	30	185	235	420	280	700
A40/100	65	2 1/2"	40	110	18x4	191	125	280	250	80	50	2000	1000	200	530	400	30	185	235	420	280	700
A40/120	65	2 1/2"	40	110	18x4	191	125	280	250	80	50	2000	1000	200	530	400	30	185	235	420	280	700
C40/140	65	2 1/2"	40	110	18x4	191	125	280	250	80	50	2000	1000	200	530	400	30	185	235	420	280	700
C40/160	65	2 1/2"	40	110	18x4	191	125	280	250	80	50	2000	1000	200	530	400	30	185	235	420	280	700
A50/100	80	3"	50	125	18x4	191	125	290	250	100	65	1800	800	200	530	400	30	185	235	420	280	700
A50/120	80	3"	50	125	18x4	191	125	290	250	100	65	1800	800	200	530	400	30	185	235	420	280	700
A50/140	80	3"	50	125	18x4	191	125	290	250	100	65	1800	800	200	530	400	30	185	235	420	280	700

* Add suction pipe: max. lenght allowed (negative suction head) in mm.

PUMP WEIGHT

table 7

H =	WR	FC	WF	WRG	FCG	WRF
500 mm	WEIGHT Kg (+/- 10%)					
C25/100	20	21	20	20	22	20
C25/120	20	22	20	21	22	21
C32/120	20	22	20	21	22	21
C32/140	44	48	44	46	50	46
C32/160	44	48	44	46	50	46
A40/100	44	48	44	46	50	46
A40/120	44	48	44	46	50	46
C40/140	44	48	44	46	50	46
C40/160	44	48	44	46	50	46
A50/100	44	48	44	46	50	46
A50/120	44	48	44	46	50	46
A50/140	44	48	44	46	50	46
H +100 mm	1,5	1,4	1,5	1,5	1,5	1,5

MOTOR WEIGHT

table 8

RATED POWER		SIZE (IEC)		WEIGHT * Kg	
kW	HP	2 Poles	4 Poles	2 Poles	4 Poles
0,25	0,35	63	71		6
0,37	0,5		71		7
0,55	0,75	71	80		9
0,75	1		80	9	10,5
1,1	1,5	80	90	11	13
1,5	2		90	14	16
2,2	3	90	100	18	23
3	4		100	24	27
4	5,5		112	30	36
5,5	7,5		132	47	
7,5	10		132	53	
11	15		160	88	
15	20		160	107	

* Indicative weight (variable depending upon the manufacturer).

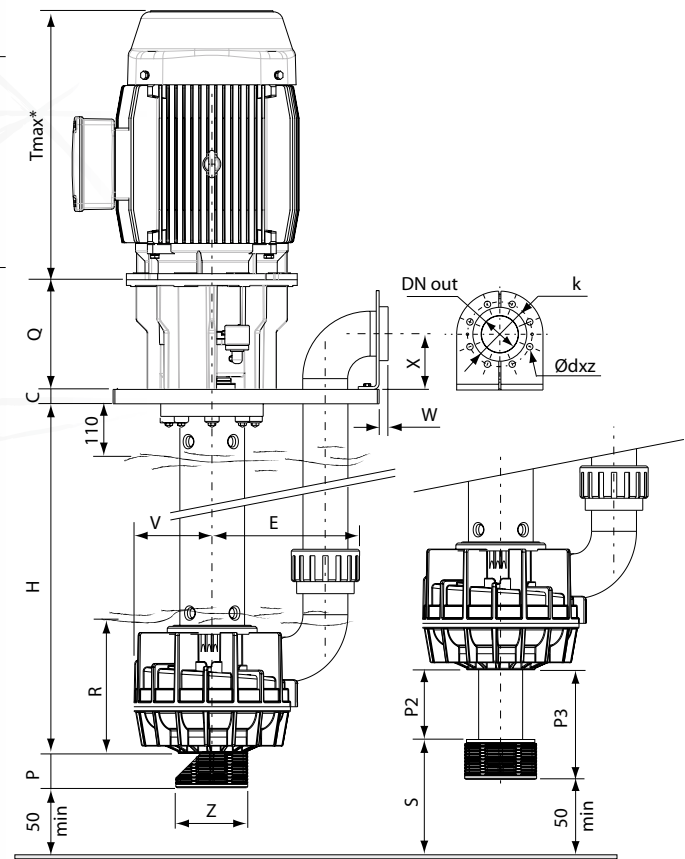
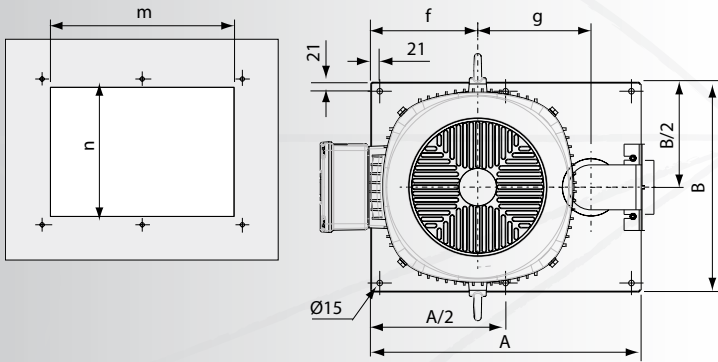

PUMP WEIGHT (Kg) WITHOUT MOTOR AND SUPPORT table 9

Model	WR	FC	WF	WRG	FCG	WFG
C40/180	21	32	22	23	34	24
C40/200	21	32	22	23	34	24
C50/160	22	33	23	24	35	25
D50/160	37	56	38	39	58	40
C50/200	24	36	25	26	38	27
D50/200	39	59	40	41	61	42
C65/160	23	35	24	25	37	26
D65/160	38	58	39	40	60	41
C65/200	25	37	26	27	39	28
D65/200	40	60	41	42	62	43
C80/160	29	43	30	31	45	32
D80/160	45	37	46	47	69	48
C80/200	29	44	30	31	46	32
D80/200	45	68	46	47	70	48
C100/160	31	47	32	33	49	34
D100/160	47	72	48	49	74	50
C100/200	31	47	32	33	49	34
D100/200	47	72	48	49	74	50

Note: weight referred to H 500 single stage - H 1000 double stage

MOTOR WEIGHT

RATED POWER		SIZE (IEC)		WEIGHT (¹) Kg	
kW	Hp	2 poles	4 poles	2 poles	4 poles
3	4	100		24	27
4	5,5	112		30	36
5,5	7,5	132		47	54
7,5	10	132		53	66
11	15	160		88	114
15	20	160		107	128
18,5	25	160	180	130	145
22	30	180		160	175
30	40	200		235	250
37	50	200	225	255	305
45	60	225		315	330

SUPPORT WEIGHT table 10

C50/160 - C40/180 - C65/160 - D50/160 - D65/160 with motor frame <f=160				Q		WEIGHT (²) Kg		Q		WEIGHT (²) Kg		T
Q		WEIGHT (²) Kg		Q		WEIGHT (²) Kg		Q		WEIGHT (²) Kg		T
2 poles	4 poles	2 poles	4 poles	2 poles	4 poles	2 poles	4 poles	2 poles	4 poles	2 poles	4 poles	max
141		26		218		37		314				
141		26		218		37		323				
161		28		238		43		400				
161		28		238		43		400				
161		31		268		49		500				
161		31		268		49		500				
161	n.a.	31	n.a.	268		49		590				
n.a.		n.a.		268		49		590				
n.a.		n.a.		286		71		680				
n.a.		n.a.		286	320	71	78	750				
n.a.		n.a.		286	320	75	78	750				

(¹) Indicative (variable depending upon the manufacturer)

(²) Support complete with bearing, coupling and shaft

DIMENSIONS

table 12

MOD.	ND in	thread in	ND out	k	Ø dxz	W	X	V	E	Rmin	S min	P	P2 max(²)	P3 max(²)	Z	A	B	C	f	g	m	n	H min
C40/180	100	4"	40	110	18x4	20	100	195	300	230	90	55	1800	800	200	630	490	40	250	251	530	390	500
C40/200	100	4"	40	110	18x4	20	100	195	300	230	90	55	1800	800	200	630	490	40	250	251	530	390	500
C50/160	100	4"	50	125	18x4	20	100	195	310	230	100	55	1800	800	200	630	490	40	250	251	530	390	500
D50/160	100	4"	50	125	18x4	20	100	195	310	460	100	55	1800	800	200	630	490	40	250	251	530	390	1000
C50/200	100	4"	50	125	18x4	20	100	195	310	230	100	55	1800	800	200	630	490	40	250	251	530	390	500
D50/200	100	4"	50	125	18x4	20	100	195	310	460	100	55	1800	800	200	630	490	40	250	251	530	390	1000
C65/160	100	4"	65	145	18x4	20	100	195	325	230	130	55	1000	n.a.	200	630	490	40	250	251	530	390	500
D65/160	100	4"	65	145	18x4	20	100	195	325	460	130	55	1000	n.a.	200	630	490	40	250	251	530	390	1000
C65/200	100	4"	65	145	18x4	20	100	195	325	230	130	55	1000	n.a.	200	630	490	40	250	251	530	390	500
D65/200	100	4"	65	145	18x4	20	100	195	325	460	130	55	1000	n.a.	200	630	490	40	250	251	530	390	1000
C80/160	125	5"	80	160	18x8	25	155	220	415	250	150	100	1000	n.a.	200	740	550	40	275	315	640	450	500
D80/160	125	5"	80	160	18x8	25	155	220	415	500	150	100	1000	n.a.	200	740	550	40	275	315	640	450	1000
C80/200	125	5"	80	160	18x8	25	155	220	415	250	150	100	1000	n.a.	200	740	550	40	275	315	640	450	500
D80/200	125	5"	80	160	18x8	25	155	220	415	500	150	100	1000	n.a.	200	740	550	40	275	315	640	450	1000
C100/160	125	5"	100	180	18x8	25	155	220	415	250	150	100	1000	n.a.	200	740	550	40	275	315	640	450	500
D100/160	125	5"	100	180	18x8	25	155	220	415	500	150	100	1000	n.a.	200	740	550	40	275	315	640	450	1000
C100/200	125	5"	100	180	18x8	25	155	220	415	250	150	100	1000	n.a.	200	740	550	40	275	315	640	450	500
D100/200	125	5"	100	180	18x8	25	155	220	415	500	150	100	1000	n.a.	200	740	550	40	275	315	640	450	1000

* Add suction pipe: max. lenght allowed (negative suction head) in mm.



Member of AIB
associazione
industriale
Bresciana

Via Labirinto, 159 - 25125 BRESCIA - ITALY
Tel. +39.030.3507011 - Fax +39.030.3507077 - Export dpt. Tel. +39.030.3507033
Web: www.argal.it - E-mail: export@argal.it

*It is the policy of ARGAL to always improve its products and the right is reserved to alter specifications at any time without prior notice.
No part of this publication may be reproduced in any form or any means.*