

# SR Series

Spring Return dosing pump  
A - piston type

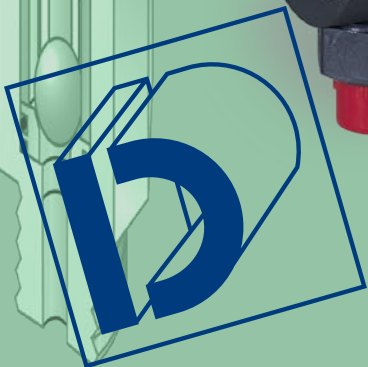
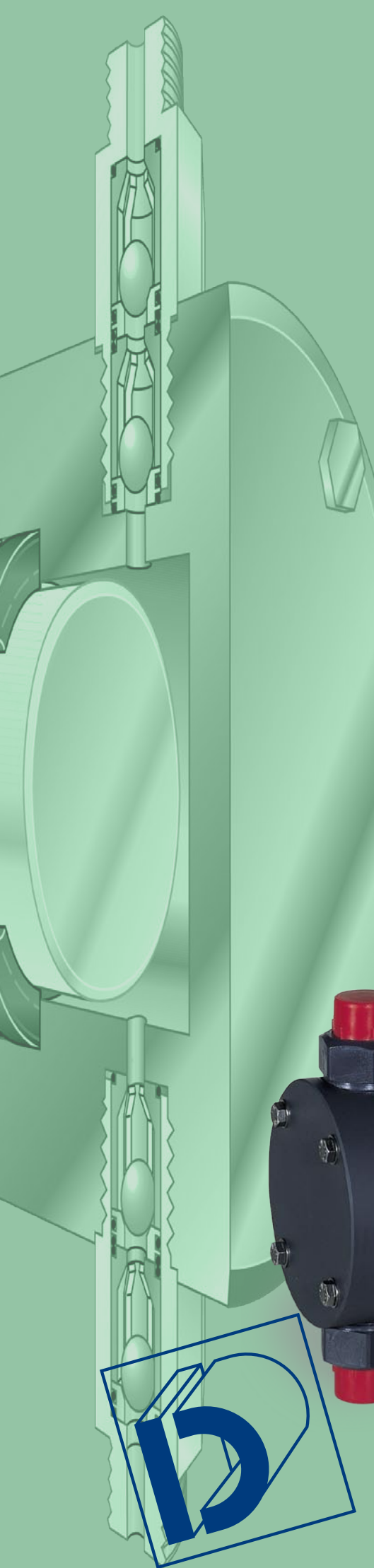

**DOSEURO®**

*The right dosing choice*



# SR Series

## MAIN ELEMENTS TO SUPPORT OUR PRODUCTS

### Versatility

Different piston sizes are available to suit different applications, starting from 0,8 until 1458 l/h

### Reliability

The high degree of accuracy and reproducibility with high quality materials selected make the piston pump SR series to assure the maximum reliability.

### Quality

The best performance for the applications is achieved by optimal selection of plunger material and seal design.

## FEATURES

Piston metering pumps are suitable for use when:

- The dosed liquid is a non abrasive solution
- A drip proof system is not essential
- High pressure is required

Each pump is fitted a standard gearbox reduction system and with a vertical mounted B14 shaped electric motor in accordance with UNEL-MEC specifications.

The motor power range is from 0.18 Kw up to 0.75 KW as the European standard: 3 phase voltages of 230/400V @ 50/60Hz, 4 pole and 1 phase voltages of 230/50-60 Hz or 110/60 Hz.

As motors conform to UNEL-MEC specifications, there are many alternative option available, including different voltages, insulation class and special explosion proof versions.



# Spring Return Plunger Dosing Pumps



## Type A and AP-A

The gearbox is a standard wormwheel reduction system with all bearings supported within a fully lubricated gearbox.

The mechanism for variation of the stroke length a positive stroke spring return that is operated by an eccentric.

### PUMPING HEADS

Pumping heads are made in standard executions: S.S. 316 or PVC

A wide range of other materials like HASTELLOY, ALLOY, PTFE, PVDF, PP are according to the liquid to be dosed.

Piston gaskets are of the lip type design and are available in a wide range of materials (FPM, EPDM, SILICONE, ADIPRENE) and also in PTFE packing. Standard liquid handled maximum temperature

- 90° C with S.S. 316 pump head
- 40° C with PVC pump head

Jacketed pump head for either cooling or heating are available to suit requirements. Piston glandling arrangements can be supplied with water washed seals to continuously flush the piston.

### PLUNGERS

There are made in S.S. 316 or Ceramics

### SUCTION AND DISCHARGE CONNECTIONS

Normally are threaded, but they can be supplied also flanged.

All the pumps have a ball valve standard: single and double balls by the function of the piston diameter or the material execution.

### STROKE ADJUSTMENT

Flow rate adjustment is possible while running or at standstill. The movement of the piston is based on a precise reciprocating gearbox, which provides an exact volumetric displacement.

Stroke adjustment can be carried out:

- Manual: by a linear micrometer screw
- Electrical: via servo motor with 4-20 mA signal upon request interface PROFIBUS or other BUS
- Pneumatic: by a pneumatic servo control with signal from 3 to 15 PSI

### MULTIPLE HEADED PUMPS

Different multiple heads units are available on request.

Each pumping element has independent adjustment while running or at standstill.

### HIGH PRESSURE EXECUTION

These pumps use the same crank mechanism of the pumps "A" type, but the difference is on the hydraulic part that must be suitable to satisfy very hard requirements.

"A" series piston pumps are available in different sizes:

- A 125 N  
Piston stroke 12.5 mm
- A 175 N  
Piston stroke 17.5 mm
- A 250 N  
Piston stroke 25 mm
- A 350 N  
Piston stroke 35 mm

For these types, 11 different piston sizes are available to suit different applications for capacity and pressure.

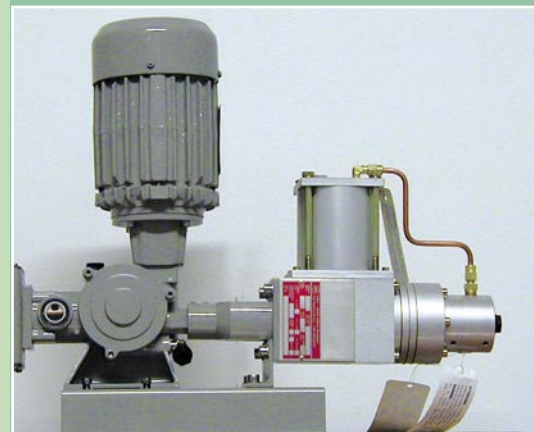



# SR Series

## SOME STANDARDS EXECUTIONS FOR PISTON PUMPS

EXECUT.	PUMPHEAD	PISTON	VALVE (ball)	VALVE SEATS	PISTON GASKETS
<b>11</b>	S.S. 316	S.S. 316	S.S. 316	S.S. 316	NBR
<b>13</b>	PVC	CERAMIC	PYREX	PVC	FPM
<b>17</b>	S.S. 316	CERAMIC	S.S. 316	S.S. 316	FPM
<b>19</b>	S.S. 316	S.S. 316	S.S. 316	S.S. 316	FPM
<b>20</b>	PVC	S.S. 316	PYREX	PVC	NBR
<b>21</b>	S.S. 316	S.S. 316	S.S. 316	S.S. 316	PTFE
<b>32</b>	S.S. 316	S.S. 420	S.S. 316	S.S. 316	AU
<b>41</b>	S.S. 316	CERAMIC	S.S. 316	S.S. 316	AU

FPM = fluoroelastomer S.S. 316 = stainless steel 316 C.O. = Chromium Oxide PP/FRV = polypropylene + glass fibber  
 Difference executions on request

## Glossary and numbering system to identify pumps type

A	125N	38/	F	11	DV
1st group	2nd group	3rd group	4th group	5th group	6th group
"A" type piston dosing pump	Stroke length	Piston diameter in mm	Reduction ratio group (N° of piston strokes/min) F(1/24) - B (1/12)	Materials in touch with the fluid	Not standard-special code

In case of pumps supplied without motor add: W/M

## GENERAL OVERALL DIMENSIONS

	125	175	250	350
<b>A</b>	57	68	75	75
<b>B</b>	90	100	127	127
<b>C</b>	70	75	120	120
<b>D</b>	75	72	70	70
<b>E</b>	378	410	450	455
<b>F</b>	90	90	154	154
<b>G</b>	70	70	130	130
<b>H</b>	115	125	157	157
<b>I</b>	65	65	102	102
<b>L</b>	7	7	9	9
<b>M</b>	140	160	194	200
<b>N</b>	32	32	60	60
<b>O</b>	80	78	78	78

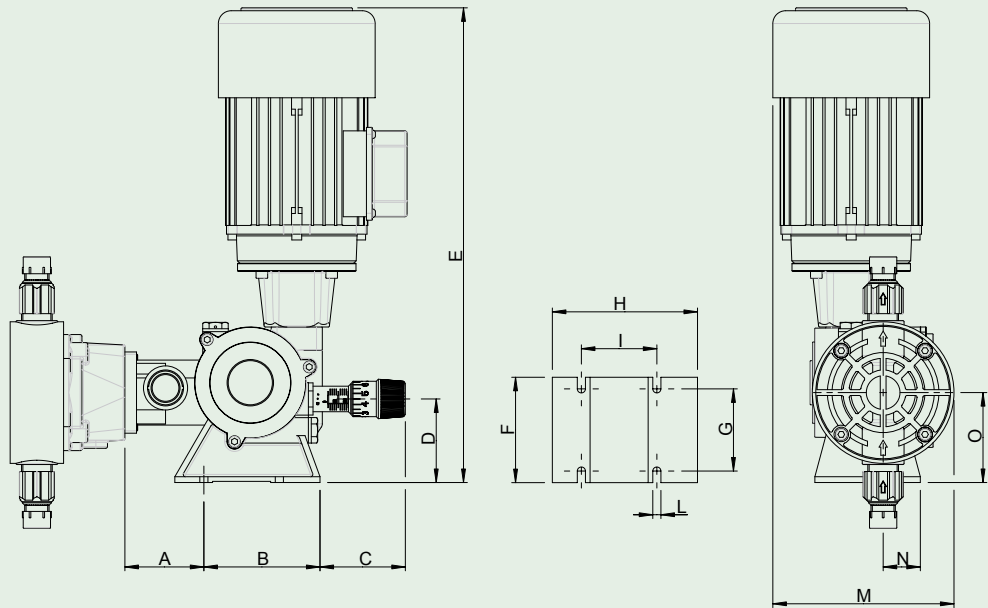

General dimensional quote are indicative and adverted to the maximum acceptable pump dimension



# Spring Return Plunger Dosing Pumps

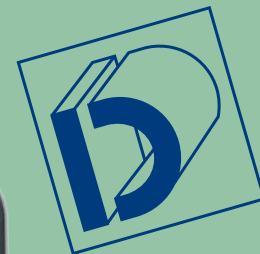

## Type A 125N



### TECHNICAL CHARACTERISTICS

Pump type	Reducer ratio			Capacity (*2)				Max Press. (*3)		Connections (*4)		Motor Features	ø mm Real piston	Stroke Length	Net Weights Kg (*5)			
	(*1)	SPM (*1)		L/1'		L/h		Kg/cm2		SS 316	PVC				SS 316	PVC	SS 316	PVC
		50 Hz	60 Hz	50 Hz	60 Hz	50 Hz	60 Hz	SS 316	PVC									
<b>A-125N-6</b>	F	58	70	0,013	0,017	0,8	1,0	20	10	1/2" G.m.	Kw 0.18 3 Ph ~1400 rpm or Kw 0.18 1 ph ~1400 rpm	6	12.5 mm	8,5	7,5			
	C	96	116	0,022	0,027	1,3	1,6											
	B	116		0,027		1,6												
<b>A-125N-11</b>	I	35	42	0,04	0,048	2,4	2,8											
	F	58	70	0,066	0,080	4	4,8											
	C	96	116	0,110	0,133	6	8											
<b>A-125N-18</b>	B	116		0,133		8												
	I	35	42	0,1	0,120	6	7,2											
	F	58	70	0,166	0,200	10	12											
<b>A-125N-25</b>	C	96	116	0,273	0,330	16	20											
	B	116		0,330		20												
	I	35	42	0,221	0,264	13,2	15,8											
<b>A-125N-30</b>	F	58	70	0,366	0,440	22	26,4											
	C	96	116	0,604	0,733	36	44											
	B	116		0,733		44												
<b>A-125N-38</b>	I	35	42	0,311	0,374	18,7	22,4											
	F	58	70	0,516	0,620	31	37,2											
	C	96	116	0,854	1,033	51	62											
<b>A-125N-47</b>	B	116		1,033		62												
	I	35	42	0,502	0,600	30	36											
	F	58	70	0,833	1,000	50	60											
<b>A-125N-55</b>	C	96	116	1,373	1,660	82	100											
	B	116		1,660		100												
	I	35	42	0,784	0,940	47	56											
<b>A-125N-63</b>	F	58	70	1,300	1,560	78	93,6											
	C	96	116	2,150	2,600	129	156											
	B	116		2,600		156												

(\*1) Piston strokes number during 1 minute with 4 poles installed motor (1400 rpm)

I = Reducer ratio 1 : 40 = 35 strokes at 50 Hz / 42 strokes at 60 Hz

F = Reducer ratio 1 : 24 = 58 strokes at 50 Hz / 70 strokes at 60 Hz

C = Reducer ratio 1 : 14,5 = 96 strokes at 50 Hz / 116 strokes at 60 Hz

B = Reducer ratio 1 : 12 = 116 strokes at 50 Hz / not suitable

(\*2) The indicated capacity value is subject to change due to the working pressure, dosed liquid, viscosity and installation asset.

(\*3) High pressures are available

(\*4) Different ranges of connections are available on request

(\*5) The weight is approximate and it is the value of the pump fitted with a totally enclosed fan-cooled outdoor motor.

(6) The pumps can be supplied with accessories if requested

(7) The pumps are epoxy coated RAL 7030



# SR Series

## Type A 175N

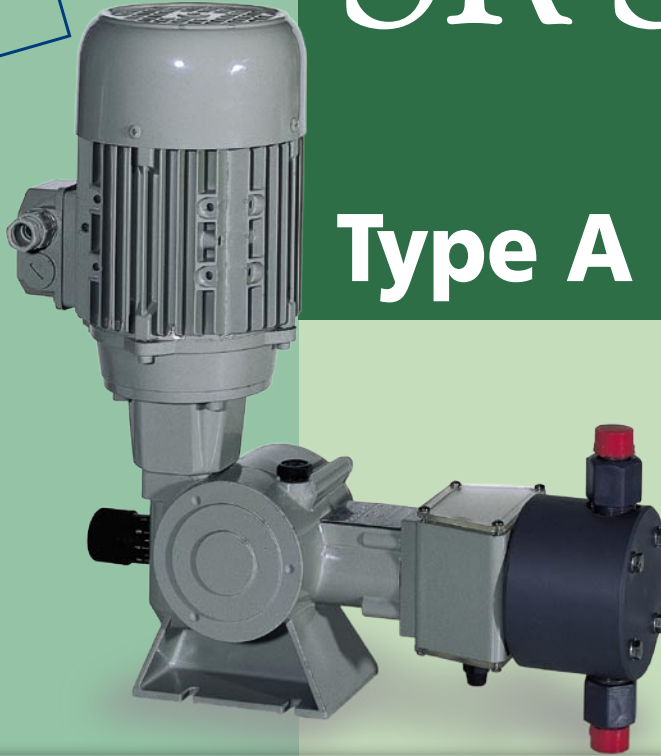

### TECHNICAL CHARACTERISTICS

Pump type	Reducer ratio (*1)			Capacity (*2)				Max Press. (*3) Kg/cm2				Connections (*4)		Motor Features	ø mm Real piston	Stroke Length	Net Weights Kg (*5)						
	(*1)	SPM		L/1'		L/h		SS 316 0,25 KW	SS 316 0,37 KW	PVC 0,25 KW	PVC 0,37 KW	SS 316	PVC				SS 316	PVC					
		50 Hz	60 Hz	50 Hz	60 Hz	50 Hz	60 Hz																
A-175N -6	F	70	84	0,021	0,026	1,3	1,56	20				1/2 " G.m.	Kw 0.25 or Kw 0.37 3 Ph ~1400 rpm or Kw 0.25 or Kw 0.37 1 Ph ~1400 rpm	6	17.5	11	10						
	C	96	116	0,029	0,035	1,7	2,11																
	B	120		0,036		2,2																	
A-175N -11	F	70	84	0,100	0,120	6	7,2													11.11		11	10
	C	96	116	0,133	0,160	8	9,6																
	B	120		0,166		10																	
A-175N -18	F	70	84	0,283	0,340	17	20,4													17.46		11	10
	C	96	116	0,400	0,480	24	28																
	B	120		0,500		30																	
A-175N -25	F	70	84	0,616	0,740	37	44,4													25.4		11	10
	C	96	116	0,853	1,024	51	61,4									10							
	B	120		1,066		64																	
A-175N -30	F	70	84	0,866	1,400	52	62,4	20	20					30.16	17.5	11	10						
	C	96	116	1,200	1,440	72	86																
	B	120		1,500		90																	
A-175N -38	F	70	84	1,383	1,660	83	99,6							38.1		12	10,5						
	C	96	116	1,920	2,304	115	138	13	20														
	B	120		2,400		144																	
A-175N -47	F	70	84	2,166	2,600	130	156							47.63		12	10,5						
	C	96	116	3,013	3,615	180	216	8.5	13	8.5	10												
	B	120		3,766		226																	
A-175N -54	F	70	84	2,800	3,360	168	201,6							53,98		15,8	12,4						
	C	96	116	3,866	4,640	232	278	6.5	10	6.5	10												
	B	120		4,830		290																	
A-175N -64	F	70	84	3,933	4,720	236	283,2							63.5		16,4	12,5						
	C	96	116	5,440	6,528	326	391	4.5	7	4.5	7												
	B	120		6,800		408																	

(\*1) Piston strokes number during 1 minute with 4 poles installed motor (1400 rpm)

F = Reducer ratio 1 : 20 = 70 strokes at 50 Hz / 84 strokes at 60 Hz

C = Reducer ratio 1 : 14,5 = 96 strokes at 50 Hz / 116 strokes at 60 Hz

B = Reducer ratio 1 : 11,5 = 120 strokes at 50 Hz / not suitable

(\*2) The indicated capacity value is subject to change due to the working pressure, dosed liquid, viscosity and installation asset.

(\*3) High pressures are available

(\*4) Different ranges of connections are available on request

(\*5) The weight is approximate and it is the value of the pump fitted with a totally enclosed fan- cooled outdoor motor.

(6) The pumps can be supplied with accessories if requested

(7) The pumps are epoxy coated RAL 7030

# Spring Return Plunger Dosing Pumps

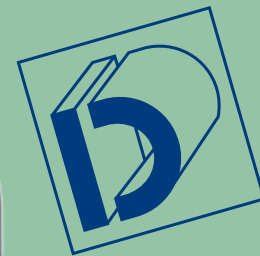

## Type A 250N and A 350N



### TECHNICAL CHARACTERISTICS

Pump type	Reducer ratio (*1)		Capacity (*2)				Max Press. (*3) Kg/cm2				Connections (*4)		Motor	ø mm Real piston	Stroke Lenght	Net Weights Kg (*5)	
	(*1)	Strokes number /1'	L/1'		L/h		SS 316 KW 0,55	SS 316 KW 0,75	PVC KW 0,55	PVC KW 0,75	SS 316	PVC				SS 316	PVC
			50 Hz	60 Hz	50 Hz	60 Hz											
<b>A-250N-25</b>	F	56	67	0,716	0,860	43	51,6					1/2 " G.m.	Kw 0.55 or Kw 0.75 3 Ph ~1400 rpm or Kw 0.55 or Kw 0.75 1 ph ~1400 rpm	25,4	21	//	
	C	96	116	1,228	1,474	73	88	20	//	//	//						
	B	112		1,433		86											
<b>A-250N-38</b>	F	56	67	1,600	1,920	96	115,2					1/2 " G.m.	Kw 0.55 or Kw 0.75 3 Ph ~1400 rpm or Kw 0.55 or Kw 0.75 1 ph ~1400 rpm	38,1	23	17	
	C	96	116	2,743	3,290	164	197,5	20	20	//	//						
	B	112		3,200		192											
<b>A-250N-47</b>	F	56	67	2,500	3,000	150	180					3/4" G.m.	Kw 0.55 or Kw 0.75 3 Ph ~1400 rpm or Kw 0.55 or Kw 0.75 1 ph ~1400 rpm	47,63	23	17	
	C	96	116	4,285	5,142	257	308	17	20	10	10						
	B	112		5,000		300											
<b>A-250N-54</b>	F	56	67	3,200	3,840	192	230,4					3/4" G.m.	Kw 0.55 or Kw 0.75 3 Ph ~1400 rpm or Kw 0.55 or Kw 0.75 1 ph ~1400 rpm	53,98	25	23.5	17.5
	C	96	116	5,485	6,582	329	395	13	17	10	10						
	B	112		6,400		384											
<b>A-250N-64</b>	F	56	67	4,433	5,320	266	319,2					1" G.m.	Kw 0.55 or Kw 0.75 3 Ph ~1400 rpm or Kw 0.55 or Kw 0.75 1 ph ~1400 rpm	63,5	25.5	20	
	C	96	116	7,600	9,120	456	547,2	9,5	12	9.5	10						
	B	112		8,860		532											
<b>A-250N-76</b>	F	56	67	6,383	7,660	383	459,6					1" G.m.	Kw 0.55 or Kw 0.75 3 Ph ~1400 rpm or Kw 0.55 or Kw 0.75 1 ph ~1400 rpm	76,2	26	20	
	C	96	116	10,943	13,131	656	787,8	6,5	8,6	6.5	8,6						
	B	112		12,760		766											
<b>A-250N-89</b>	F	56	67	8,683	10,420	521	625,2					1" G.m.	Kw 0.55 or Kw 0.75 3 Ph ~1400 rpm or Kw 0.55 or Kw 0.75 1 ph ~1400 rpm	88,9	29	20	
	C	96	116	14,885	17,862	893	1071,7	4,8	6,3	4.8	6,3						
	B	112		17,360		1042											
<b>A-350N-89</b>	F	56	67	12,150	14,566	729	874					1 1/2" G.m.	Kw 0.75	88,9	35	35	24
	C	96	116	20,816	24,966	1249	1498	//	4	//	4						
	B	112		24,300		1458											

(\*1) Piston strokes number during 1 minute with 4 poles installed motor (1400 rpm)

F = Reducer ratio 1 : 25 = 56 strokes at 50 Hz / 67 strokes at 60 Hz

C = Reducer ratio 1 : 14,5 = 96 strokes at 50 Hz / 116 strokes at 60 Hz

B = Reducer ratio 1 : 12,5 = 112 strokes at 50 Hz / not suitable

(\*2) The indicated capacity value is subject to change due to the working pressure, dosed liquid, viscosity and installation asset.

(\*3) High pressures are available

(\*4) Different ranges of connections are available on request

(\*5) The weight is approximate and it is the value of the pump fitted with a totally enclosed fan-cooled outdoor motor.

(6) The pumps can be supplied with accessories if requested

(7) The pumps are epoxy coated RAL 7030



# SR Series

## Type AP-A 125N

Pump type	Reducer ratio (*1)			Capacity (*2)				Max Press. (*3) Kg/cm <sup>2</sup>		Connections (*4)	Motor features	Real piston Ø mm	Stroke length mm	Net weights Kg (*5)
	(1*)	SPM		L/1'		L/h		SS 316						
		50 Hz	60 Hz	50 Hz	60 Hz	50 Hz	60 Hz	Kw 018	Kw 025	SS 316				SS 316
AP A-125N - 8	I	35	42	0,019	0,022	1,1	1,3	95	250	1/2" G.m.	Kw 0,18 3 ph ~ 1400 rpm or kw 0,18 ~ 1400 rpm 1 ph	8	12,5	9
	F	58	70	0,031	0,036	1,9	2,2							
	C	96	116	0,051	0,061	3,1	3,7							
	B	116		0,061		3,7								
AP A-125N - 12	I	35	42	0,044	0,052	2,6	3,1	88	170	1/2" G.m.	Kw 0,18 3 ph ~ 1400 rpm or kw 0,18 ~ 1400 rpm 1 ph	12	12,5	9
	F	58	70	0,073	0,086	4,4	5,2							
	C	96	116	0,120	0,143	7,2	8,6							
	B	116		0,143		8,6								
AP A-125N - 14	I	35	42	0,060	0,070	3,6	4,2	65	125	1/2" G.m.	Kw 0,18 3 ph ~ 1400 rpm or kw 0,18 ~ 1400 rpm 1 ph	14	12,5	9
	F	58	70	0,100	0,116	6	7							
	C	96	116	0,165	0,196	9,9	11,8							
	B	116		0,196		11,8								
AP A-125N - 16	I	35	42	0,078	0,094	4,7	5,6	50	96	1/2" G.m.	Kw 0,18 3 ph ~ 1400 rpm or kw 0,18 ~ 1400 rpm 1 ph	16	12,5	9
	F	58	70	0,130	0,155	7,8	9,4							
	C	96	116	0,215	0,256	13	15,6							
	B	116		0,256		15,6								

(\*1) Piston strokes number during 1 minute with 4 poles installed motor (1400 rpm)  
 I = Reducer ratio 1 : 40 = 35 strokes at 50 Hz / 42 strokes at 60 Hz  
 F = Reducer ratio 1 : 24 = 58 strokes at 50 Hz / 70 strokes at 60 Hz  
 C = Reducer ratio 1 : 14,5 = 96 strokes at 50 Hz / 116 strokes at 60 Hz  
 B = Reducer ratio 1 : 12 = 116 strokes at 50 Hz / not suitable at 60 Hz

## Type AP-A 175N

Pump type	Reducer ratio (*1)			Capacity (*2)				Max Press. (*3) Kg/cm <sup>2</sup>		Connections (*4)	Motor features	Real piston Ø mm	Stroke length mm	Net weights Kg (*5)
	(1*)	SPM		L/1'		L/h		SS 316						
		50 Hz	60 Hz	50 Hz	60 Hz	50 Hz	60 Hz	Kw 025	Kw 037	SS 316				SS 316
AP A - 175N - 8	F	70	84	0,055	0,066	3,3	3,9	95	250	1/2" G.m.	Kw 0,25 3 ph ~ 1400 rpm or kw 0,25 ~ 1400 rpm 1 ph	8	17,5	11
	C	96	116	0,075	0,090	4,5	5,4							
	B	120		0,093		5,6								
AP A - 175N - 12	F	70	84	0,123	0,147	7,4	8,8	95	233	1/2" G.m.	Kw 0,25 3 ph ~ 1400 rpm or kw 0,25 ~ 1400 rpm 1 ph	12	17,5	11
	C	96	116	0,168	0,201	10,1	12,1							
	B	120		0,210		12,6								
AP A - 175N - 14	F	70	84	0,188	0,225	11,3	13,5	95	171	1/2" G.m.	Kw 0,25 3 ph ~ 1400 rpm or kw 0,25 ~ 1400 rpm 1 ph	14	17,5	11
	C	96	116	0,256	0,307	15,4	18,4							
	B	120		0,321		19,3								
AP A - 175N - 16	F	70	84	0,245	0,294	14,7	17,6	75	131	1/2" G.m.	Kw 0,25 3 ph ~ 1400 rpm or kw 0,25 ~ 1400 rpm 1 ph	16	17,5	11
	C	96	116	0,335	0,402	20,1	24,1							
	B	120		0,420		25,2								
AP A - 175N - 18	F	70	84	0,280	0,336	16,8	20,1	59	102	1/2" G.m.	Kw 0,25 3 ph ~ 1400 rpm or kw 0,25 ~ 1400 rpm 1 ph	18	17,5	11
	C	96	116	0,383	0,459	23	27,6							
	B	120		0,476		28,6								

(\*1) Piston strokes number during 1 minute with 4 poles installed motor (1400 rpm)  
 F = Reducer ratio 1 : 20 = 70 strokes at 50 Hz / 84 strokes at 60 Hz  
 C = Reducer ratio 1 : 14,5 = 96 strokes at 50 Hz / 116 strokes at 60 Hz  
 B = Reducer ratio 1 : 11,5 = 120 strokes at 50 Hz / not suitable at 60 Hz





# High pressure Spring Return Plunger Dosing Pumps Type AP-A 250N

Pump type	Reducer ratio (*1)			Capacity (*2)				Max Press. (*3) Kg/cm2		Connections (*4)	Motor features	Real piston Ø mm	Stroke length mm	Net weights Kg (*5)
	(1*)	SPM		L/1'		L/h		SS 316						
		50 Hz	60 Hz	50 Hz	60 Hz	50 Hz	60 Hz	Kw 0,55	Kw 0,75	SS 316				
<b>AP A 250N - 12</b>	F	56	67	0,141	0,169	8,5	10,2	95	196	1/2" G.m.	Kw 0,55 or Kw 0,75 3 ph ~ 1400 rpm or kw 0,55 or Kw 0,75 ~ 1400 rpm 1 ph	25	20	
	C	96	116	0,241	0,289	14,5	17,4							
	B	112		0,281		16,9								
<b>AP A 250N - 14</b>	F	56	67	0,193	0,231	11,6	13,9							
	C	96	116	0,330	0,396	19,8	23,8							
	B	112		0,385		23,1								
<b>AP A 250N - 16</b>	F	56	67	0,251	0,301	15,1	18,2							
	C	96	116	0,430	0,516	25,8	31							
	B	112		0,500		30								
<b>AP A 250N - 18</b>	F	56	67	0,320	0,384	19,2	23							
	C	96	116	0,548	0,657	32,9	39,4							
	B	112		0,638		38,3								
<b>AP A 250N - 20</b>	F	56	67	0,395	0,474	23,7	28,4							
	C	96	116	0,676	0,811	40,6	48,7							
	B	112		0,788		47,3								
<b>AP A 250N - 22</b>	F	56	67	0,478	0,573	28,7	34,4	79	104			22	22	
	C	96	116	0,820	0,984	49,2	59							
	B	112		0,956		57,4								
<b>AP A 250N - 25</b>	F	56	67	0,616	0,740	37	44,4	61	80			25	22	
	C	96	116	1,058	1,270	63,5	76,2							
	B	112		1,235		74,1								

(\*1) Piston strokes number during 1 minute with 4 poles installed motor (1400 rpm)  
 F = Reducer ratio 1 : 25 = 56 strokes at 50 Hz / 67 strokes at 60 Hz  
 C = Reducer ratio 1 : 14,5 = 96 strokes at 50 Hz / 116 strokes at 60 Hz  
 B = Reducer ratio 1 : 12,5 = 112 strokes at 50 Hz / not suitable at 60 Hz

- (\*2) The indicated capacity value is subject to change due to the working pressure, dosed liquid, viscosity and installation asset.  
 (\*3) High pressures are available  
 (\*4) Different ranges of connections are available on request  
 (\*5) The weight is approximate and it is the value of the pump fitted with a totally enclosed fan-cooled outdoor motor.  
 (6) The pumps can be supplied with accessories if requested  
 (7) The pumps are epoxy coated RAL 7030



# Accessories



## Safety relief valves

Type	Pump capacity	Connections
<b>TS-10</b>	200 l/h	3/8" or 1/2"
<b>TS-13</b>	400 l/h	1/2" G.F
<b>TS-21</b>	1000 l/h	1" G.F
<b>Body</b>	PVC or S.S. 316	

\* S.S. 316 Relief - Safety valve setting pressure: max 40 kg/cm<sup>2</sup> (588 Psi) higher pressures are available on request.  
PVC Relief safety valve setting pressure: max 10 kg/cm<sup>2</sup> (145 Psi).  
For higher setting pressures consult our technical dept.



## Pulsation dampeners

Type: HSTX  
Body in S.S.316, composed of two parts assembled by a special hosing that under dynamic pressures tends to close itself. Diaphragms are compatible to the liquid used. Built in accordance with ASME VIII° Div. 1 rules.



Type: HSTPVC  
Body in PVC, composed of two parts assembled by a special hosing that under dynamic pressures tends to close itself. Maximum temperature: + 50 °C. Diaphragms are compatible with the process liquid.

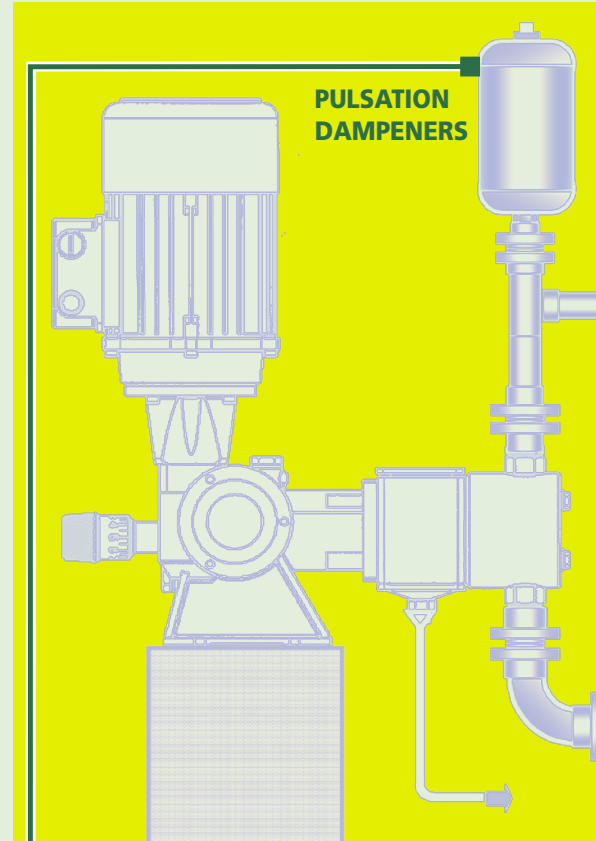

Each metering pump can be supplied with accessories in order to improve the operation and accuracy of the units.

The benefits of fluid control assure

- Increase efficiency and pump life
- Decrease maintenance and operation costs

The control of fluid dynamics is essential to ensure efficient and safe use of process systems. Uncontrolled fluid in motion can physically destroy. A pumping system including the pumping, valves, meters, back pressure valves, inline instrumentation and equipment.

### 1.- FILTERS

We suggest to install filters (on the suction pipe) to keep back impurities that can be presented on liquid to be dosed or coming from pipeline system.

The use of filters assures a trouble-free dosing.

### 2.- SAFETY VALVES

Safety valves are designed to protect the pump and chemical feed system from over pressure damage caused by defective equipment or a blockage in the chemical feed line.

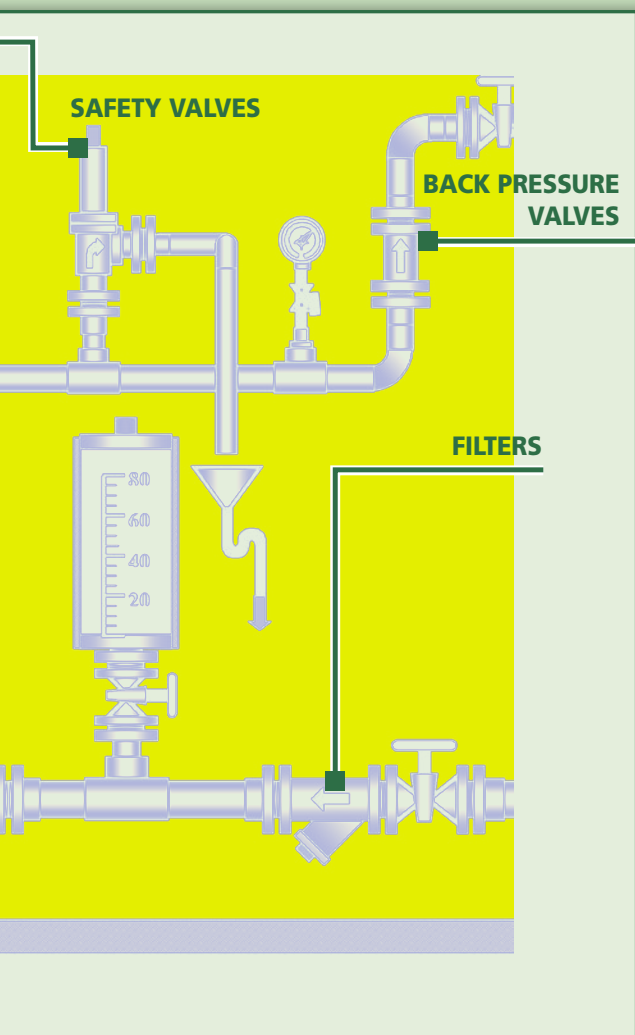
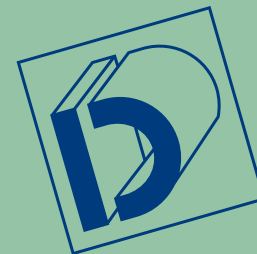

### Relief valves and back pressure valves

Type	Pump Capacity	Connections
VSC-6	90 l/h	1/2" G.F
VSC-10	230 l/h	1/2" G.F
VSC-14	420 l/h	3/4" G.F
VSC-22	1050 l/h	1" G.F
<b>Body</b>	PVC or S.S. 316	
<b>Diaphragm</b>	PTFE/NBR	

\* Relief valve setting pressure: 3/10 kg/cm<sup>2</sup> (44/145 Psi)  
 Back pressure valve setting pressure: 1/3 kg/cm<sup>2</sup> (15/44Psi)  
 G.F.= Cylindrical, Female



### Polyethylene tanks

suitable to be fitted with metering pump on its top



#### 3.- BACK PRESSURE VALVES

Back pressure valves apply positive discharge pressure to a metering pump system to prevent siphoning and eliminate varying downstream pressure.

#### 4.- PULSATION DAMPENER

Metering pumps have a pulsating flow. Both spring return plunger dosing pumps and quick closing valves start and stop fluids that are in motion. Spring return plunger dosing pumps derive their pumping action by capturing a given amount of fluid in a chamber and pushing it out the pump's discharge.

Each pump cycle includes a suction stroke during the fluid flow is stopped. This pumping action produces an acceleration/deceleration of the fluid, creating units of uncontrolled energy, resulting in PULSATION, observed as pressure spikes.

Pulsation dampener is required for two reasons:  
 - To reduce high, non-permissible pressure fluctuations.  
 - To create a nearly continuous flow.



Our range of production also includes:

**SR series:**

Hydraulic diaphragm dosing pumps "B", "BR" and "SD" types  
Mechanical diaphragm dosing pumps "D" and "FM" types

**PDP series:**

Positive displacement dosing pump "AI" and "SDI" types  
High pressure positive displacement dosing pump "AP-AI" types

**SDP series:**

Solenoid dosing pumps "S" type  
Solenoid dosing pumps "GA" type

**H series:**

Automatic plants for dissolution and preparation of powder polyelectrolytes "HA", "HB" types

**EM series:**

Electric mixers for chemical mixing "DMT", "DEM", "DRV" and "DRC" types



**HEAD OFFICE**

Via G. Carducci 141  
20093 Cologno Monzese (MI) Italy  
Tel.: +39 02 27301324  
Fax: +39 02 26700883  
e-mail: [info@doseuro.com](mailto:info@doseuro.com)  
[www.doseuro.com](http://www.doseuro.com)

**DOSEURO (UK) LTD.**

Unit 8, East Road Industrial Estate  
Sleaford, Lincolnshire NG34 7EH  
Tel.: +44 1529 300045  
Fax: +44 1529 410967  
e-mail: [info@doseuro.co.uk](mailto:info@doseuro.co.uk)  
[www.doseuro.co.uk](http://www.doseuro.co.uk)



**DOSEURO®**  
*The right dosing choice*