

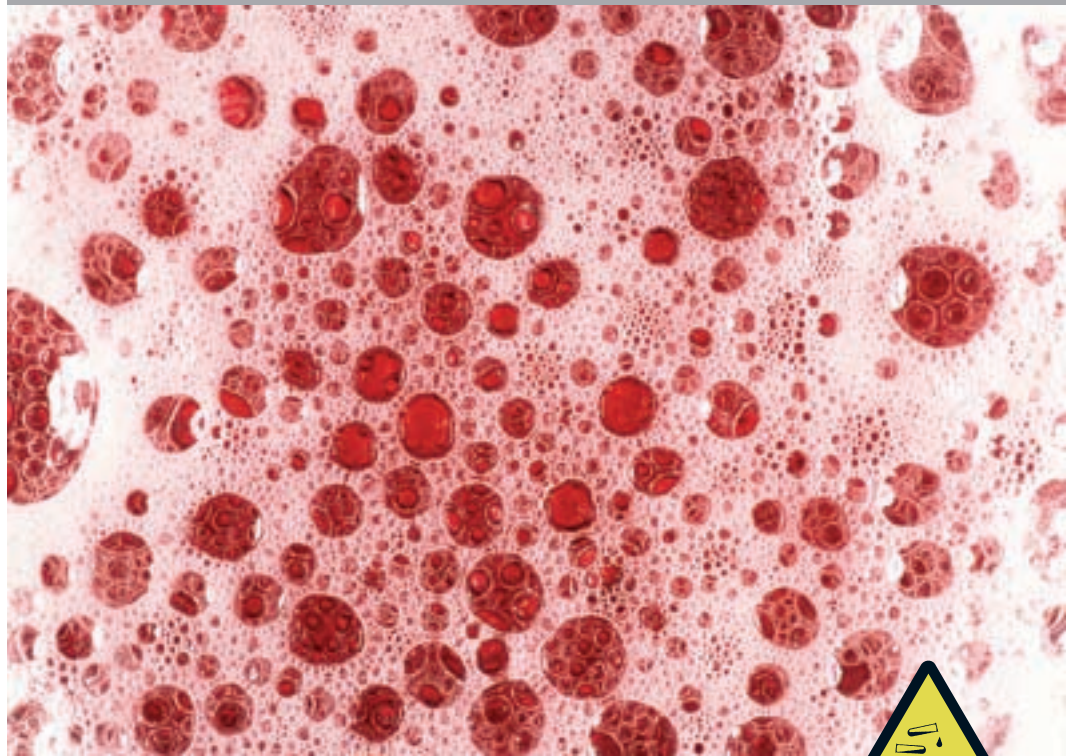

SEALLESS

DRUM PUMPS PVDF

FOR HIGH AGGRESSIVE LIQUIDS
THE RIGHT DRUM PUMPS



- This saves maintenance costs
- This avoids malfunctions
- This saves time
- This saves money

**If you have such applications,
take only the best.**



PVDF drum pumps take no ...



... and environment.



fright at any application ...



Advantages for the reliability

This saves maintenance costs

- robust coupling
- strong shaft
- stainless steel for stressed parts
- new development without seal



Advantages for the operational safety

This avoids malfunctions

- optional magnetic clutch for hermetical sealed pump
- strong connection motor-pump



Advantages for the user

This saves time

- quick release coupling
- no problems with failed threads



Advantages for the customer

This saves money

- one supplier for the most applications
- one motor for all types of impeller
- less equipment required

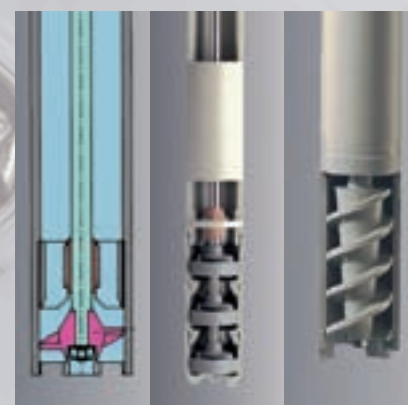

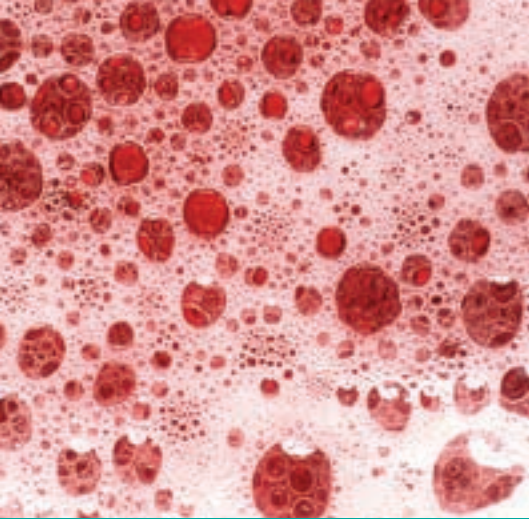

DRUM PUMPS PVDF

FOR HIGH AGGRESSIVE LIQUIDS
THE RIGHT DRUM PUMPS

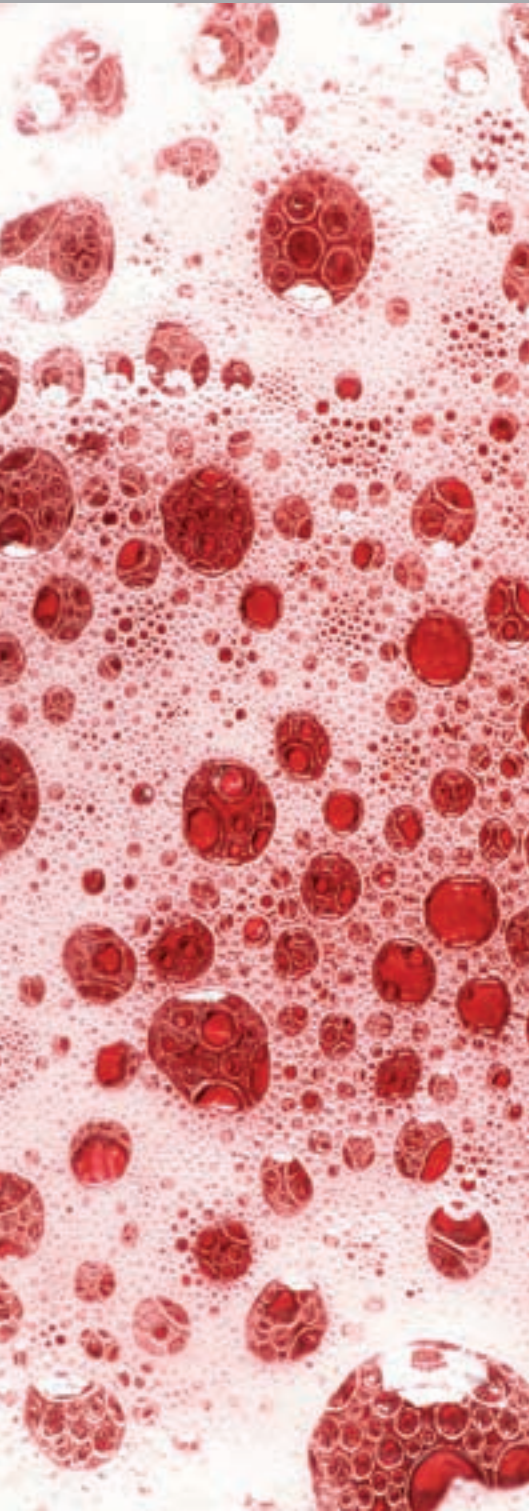

SEALLESS



- **acid, concentrated**
- **bases, concentrated**
- mineral oil
- colours
- emulsions
- dispersions
- suspensions
- fluids of medium viscosity
- cosmetics



For high aggressive liquids...

Version A, R column 1-2, page 7

For high aggressive and li- quids of medium viscosity...

Version S column 3, page 7

SL-PVDF:

For transfilling and draining of drums and containers.

The perfect drum pump for the most thin liquids. Version A for high flow rate, Version R for high pressure, with foot valve for complete drainage.

Recommendation:

For heavy liquids the strong motor p400-A.

SL-PVDF-S:

The feed screw (S) is dedicated for liquids of medium viscosity ($\eta > 200$ mPas), if the impeller types A and R reach their limitations.

With induction motor ideal combination for gentle dealing with the liquid.

Recommendation:

Induction motor with frequency inverter, for variable flow rate.

Sealless pumping units

Sealless pump tubes from grün are reliable without using a mechanical seal and are suitable for almost any aggressive, low viscosity media. Our sealless pumping units are available in PP, PVDF, stainless steel (SS) and aluminium (Alu) material versions.

(Separate brochure for each material available).

Design PVDF:

The pump tube (3) is divided by the inner tube into sections to separate the fluid under pressure (3 flow channels) and the low pressure section (wave channel).

Advantages of sealless drum pumps

► Cleaning the pumping unit is greatly facilitated; the risk of fluid carry-over when moving the pump to a different container is minimized.

► The build-in webs add considerable rigidity to the pump tube, resulting in greatly improved mechanical stability of the pumping unit.

► No bearings in the wave channel.

► Motor power is transferred by proven, robust coupling (1) with curved teeth over the stainless steel coupling element (2) with a large double bearing.

► Of course, the sealless pump tubes are fully compatible with the sealed models, allowing you to use the pumping units with any motor from grün product range.

► Depending on the application you can select one of 3 different types of impellers: axial (A), radial (R) and feed screw (S).

Product profile

A drum pump always consists of a pump tube and a motor. These components are connected by means of a quick coupling. Any pump tube can be used with any motor.

Selecting the right order-no.

In the general order-no., for example 500-00XX, fill in the specific numbers for your choice.
 Example: p400-A 230V:
 Order-No. 500-0024



- **optimised in price**
- **short and occasional usage**
- **it likes light and thin liquids**
- **opt. LVR: low voltage release for advanced safety**
- **opt. SR: speed reducer for simple flow rate variation**

Motor		Pump tube
p310		Performance curve
		Hydr. Values
Power (W)	520	Capacity Q (l/min)
Voltage (V)	230 / 120	Delivery head H (mWS)
Protection	IP 24	Density ρ (kg/l)
LVR*	optional	Viscosity η (mPas)
Weight (kg)	3,5	Weight (kg)
		Temperature (°C)
Order-No.	500-00XX	L (mm)
Voltage (V)	230 120	700
p310 (LVR)	16 28	1000
p310-A	17 29	1200
p310-A-SR	54 -	



- **the ideal drive**
- **big resources in power and durability**
- **quick working and saving time**
- **opt. LVR: low voltage release for advanced safety**
- **opt. SR: speed reducer for simple flow rate variation**
- **opt. IP 54: 230V**
- **Order-No. 500-0052**

Motor		Pump tube
p400		Performance curve
		Hydr. Values
Power (W)	850	Capacity Q (l/min)
Voltage (V)	230 / 120	Delivery head H (mWS)
Protection	IP 24	Density ρ (kg/l)
LVR*	optional	Viscosity η (mPas)
Weight (kg)	4	Weight (kg)
		Temperature (°C)
Order-No.	500-00XX	L (mm)
Voltage (V)	230 120	700
p400 (LVR)	23 25	1000
p400-A	24 26	1200
p400-A-SR	56 -	



- **the power drive**
- **variable speed**
- **starting knob fixable**
- **for heavy duty**
- **easy handling**
- **economical air consumption**

Motor		Pump tube
d600		Performance curve
		Hydr. Values
Power (W)	600	Capacity Q (l/min)
Pressure (bar)	3-7	Delivery head H (mWS)
Consumption of air (l/s)	10	Density ρ (kg/l)
Weight (kg)	1,7	Viscosity η (mPas)
		Weight (kg)
		Temperature (°C)
	Order-No.	L (mm)
d600	520-0016	700
		1000
		1200



- **the silent marathon worker**
- **ideal for viscous liquids**
- **smooth product treatment with feed screw**
- **voltage 230 V (1-ph) and 400 V (3-ph)**
- **opt.: with frequency inverter**
- **opt.: Ex-proof versions**

Motor		Pump tube
pd500		Performance curve
		Hydr. Values
Power (W)	see below	Capacity Q (l/min)
Voltage (V)	230 / 400	Delivery head H (mWS)
Protection	IP 54	Density ρ (kg/l)
Overload release	1 ph: yes 3 ph opt.	Viscosity η (mPas)
Weight (kg)	5	Weight (kg)
		Temperature (°C)
	Order-No.	L (mm)
d500-1 370W	500-0042	700
		1000
d500-3 370W	500-0039	1200

* LVR: Low voltage release (restart protection)

1	2	3
SL-PVDF-A	SL-PVDF-R	SL-PVDF-S
A100	R100	
max	max	
100	90	
6	14	
1,3	1,6	
300	250	
1,8	1,8	
80	80	
Order-No.	Order-No.	
680-0001	685-0001	
680-0002	685-0002	
680-0003	685-0003	

1	2	3
SL-PVDF-A	SL-PVDF-R	SL-PVDF-S
A200	R200	S200
max	max	max
110	100	55
8	20	10
1,6	2,0	1,5
800	700	700
1,8	1,8	2
80	80	80
Order-No.	Order-No.	Order-No.
680-0001	685-0001	680-0006
680-0002	685-0002	680-0007
680-0003	685-0003	680-0008

1	2	3
SL-PVDF-A	SL-PVDF-R	SL-PVDF-S
A600	R600	S600
max	max	max
90	80	60
7	15	8
1,6	2	1,5
800	700	700
1,8	1,8	2
80	80	80
Order-No.	Order-No.	Order-No.
680-0001	685-0001	680-0006
680-0002	685-0002	680-0007
680-0003	685-0003	680-0008

1	2	3
SL-PVDF-A	SL-PVDF-R	SL-PVDF-S
		S500
		max
		15
		7
		1,9
		1500 (min 100)
		2
		80
		Order-No.
		680-0006
		680-0007
		680-0008

Other voltages on demand.

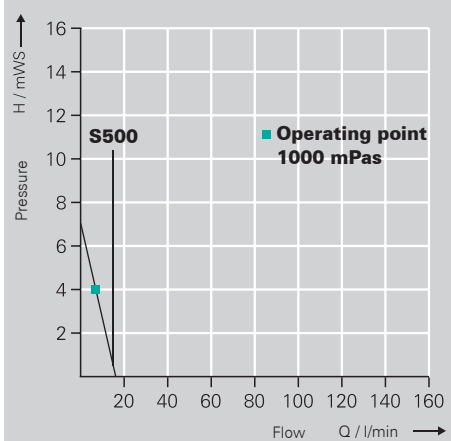
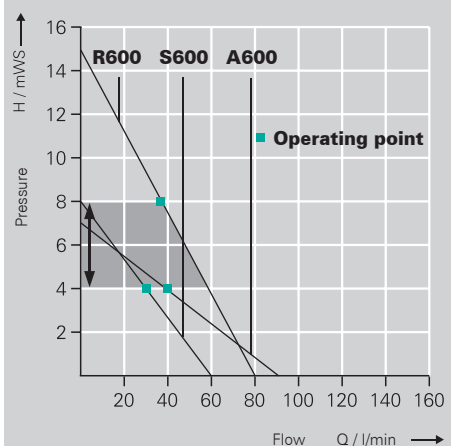
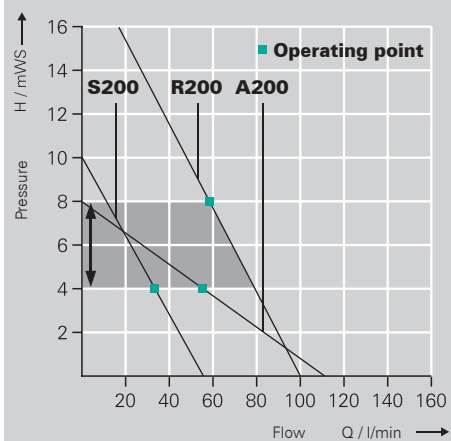
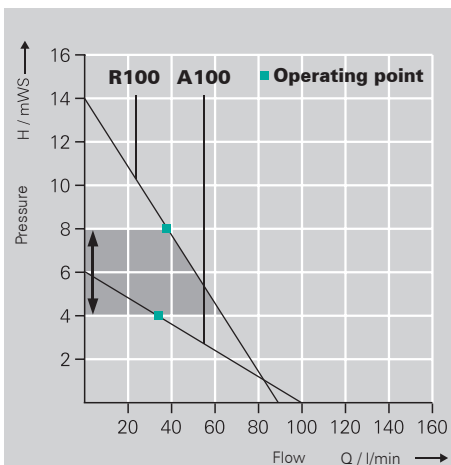
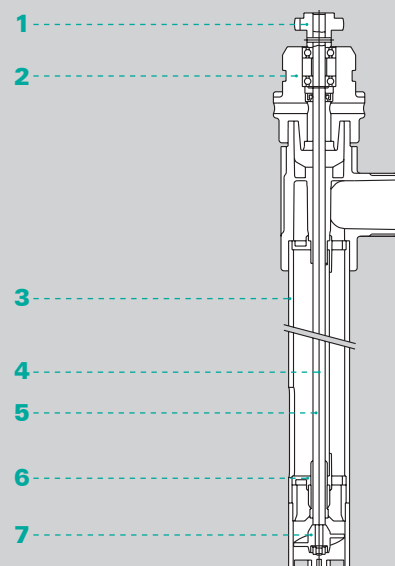

Table of materials

Description	Pump tube version PVDF
1. Curved teeth coupling	PA
2. Coupling element	PVDF/SS
3. Pump tube with flow and wave channel	PVDF
4. Drive shaft	HC
5. Wave channel	PVDF
6. Slide bearing	PTFE
7. Impeller	ETFE



Cross-section of pump:

When fluid enters the wave channel, a surge hole allows it to escape into the fluid area surrounding the pumping unit. In the wave channel is no overpressure and the fluid level in both (wave channel and drum) is always the same. For this reason the pump doesn't need a seal between drive shaft and housing.

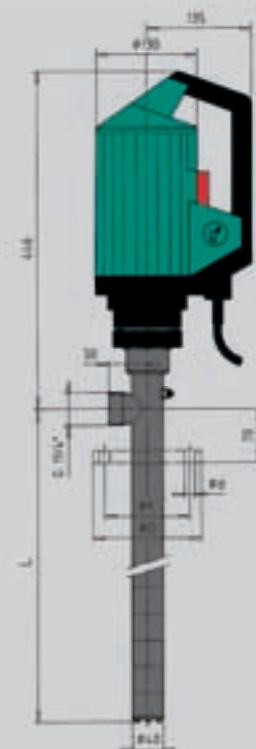

**Mechanical sealed (MS) pumps
in separate catalogue.**



ACCESSORIES

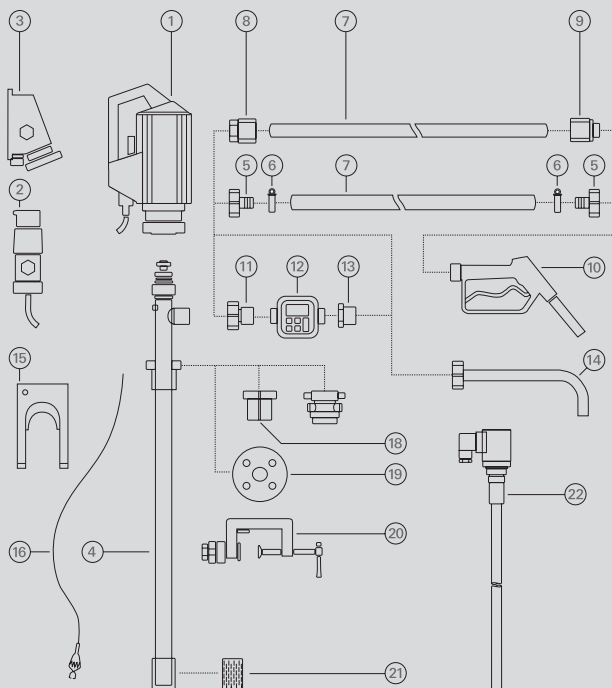

- 1 Drive motor
- 2 Explosion-proof plug
- 3 Explosion-proof socket
- 4 Pump tube
- 5 Hose connector
- 6 Hose clamps
- 7 Hose
- 8 Hose fittings
- 9 Hose fittings
- 10 Nozzle
- 11 Flow meter connection
- 12 Flow meter
- 13 Reducing piece
- 14 Discharge spout
- 15 Wall bracket
- 16 Equipotential bonding cable
- 17 Emission proof drum adapter
- 18 Drum adapter
- 19 Installation flange
- 20 Clamping device
- 21 Foot strainer
- 22 Level switch

Distributor:

grün-pumpen gmbh
Otto-Schott Str. 19
D-97877 Wertheim
Telefon +49 93 42 9 35 16-0
Telefax +49 93 42 9 35 16-29
info@gruen-pumpen.de
www.gruen-pumpen.de

Handelsregister:
Reg. Gericht Mannheim
HRB 570326
Sitz der Gesellschaft:
Wertheim
Geschäftsführer:
Ralph Dostmann, Dr. Thomas Sigel
USt.IdNr. DE 160765854

g[®]
grün-pumpen
 take out, what's in.