

I Applications

The DIN-FOOD pump is a hygienic high capacity centrifugal pump (up to 1000 m³/h) designed to cater for an unfulfilled need in the food-processing and chemical and pharmaceutical industries.

Its applications include processes in the brewing, dairy and beverage industries in general, as well as in ultra-filtering processes. It can also be used in the textile industry and in some specific processes in the chemical, cosmetics and pharmaceutical industries.

I Operating principles

Housed inside the casing, the impeller rotates in conjunction with the pump shaft.

With this arrangement, the impeller blades convey energy to the fluid in the form of kinetic energy and pressure energy.

This pump is not reversible by a simple reversal of the direction of rotation. The direction of rotation is clockwise when the pump is viewed from the rear side of the motor.

I Design and features

Casing with volute manufactured with 8 mm cold-formed plate.

Aseptic flanges according to DIN 11864-2.

Double curvature impeller with blades on the rear side to reduce the axial thrust.

Axial adjustment of the impeller (bare shaft version).

Hygienic mechanical seal.

Fully drainable pump.

Designed according to the EHEDG standards.

IEC B3 motors (B35 close-coupled constructions), IP 55, F-class insulation.

I Materials

Parts in contact with pumped media

AISI 316L

Lantern and bearing support

CF8 / GG-22

Gaskets

EPDM according to FDA 177.2600

Mechanical seal

SiC/C/EPDM

Inside surface finish

Ra ≤ 0.8

Outside surface finish

Satin finish

I Options

Close-coupled construction for models 250.

Mechanical seal in SiC/SiC for abrasive materials.

Tandem type mechanical seal and pressurized double mechanical seal.

Gaskets: FPM and PTFE.

Industrial finish (DIN-TEX).

Motor shroud.

Motors with additional protection.

Stainless steel base plate.

ATEX version available.



Aseptic connections DIN 11864-2



Hygienic mechanical seal

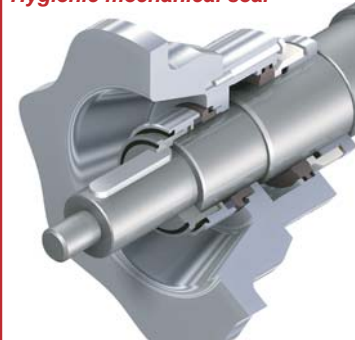

I Technical specifications

Max. flow	1000 m ³ /h	4403 US GPM
Max. differential head	90 mwc	295 ft
Max. operating pressure	10 bar	145 PSI
Max. working temperature	-10 °C to +120 °C (EPDM)	14 °F to 248 °F
	+140 °C (SIP, max. 30 min)	284 °F
Max. speed	1800 rpm	
	3600 rpm (model 125-100-250/2)	

I General dimensions

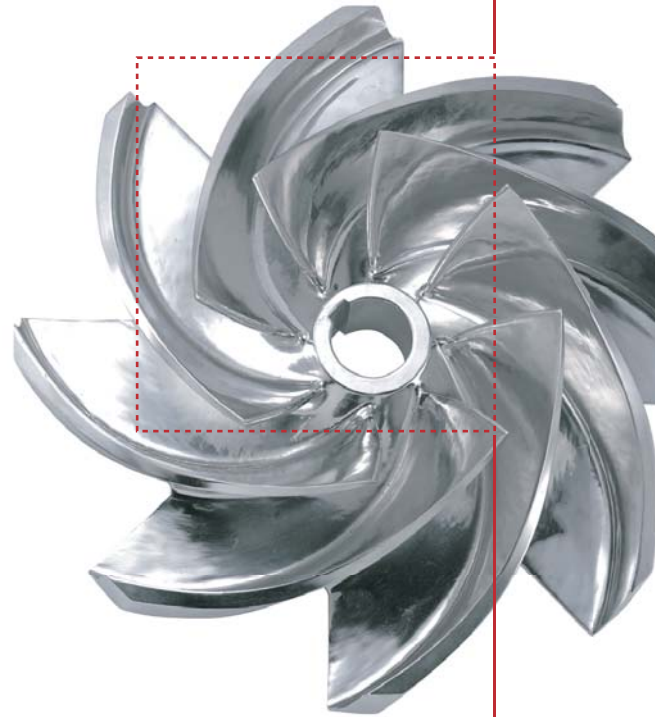
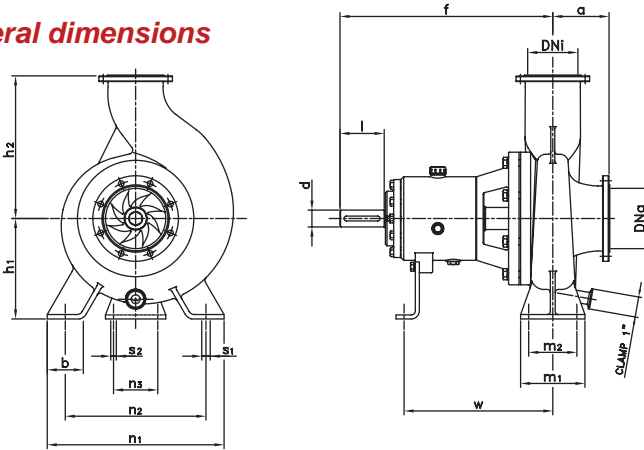

Pump	DNa	DNi	d	l	a	f	h ₁	h ₂	b	m ₁	m ₂	n ₁	n ₂	n ₃	s ₁	s ₂	w
125-100-250					121	522	250	316				440	350				363
125-100-315	125	100	42	110		510	280	352	90	160	120	490	400	110	18	14	350
125-100-400					130	510	330	402	100	200	150	550	450		23		
150-125-250					128	530	250	355		90	160	440	350		18		370
150-125-315	150	125	42	110	137	518	280	372		200	150	490	400	110	23	14	358
150-125-400					140	518	330	422	100			550	450				
200-150-250			42		142	537	250	375				440	350	110		14	378
200-150-315	200	150		110		670	280	402	90	200	150	490	400		23		500
200-150-400			48		153	667	330	452	100			550	450	140	18		498

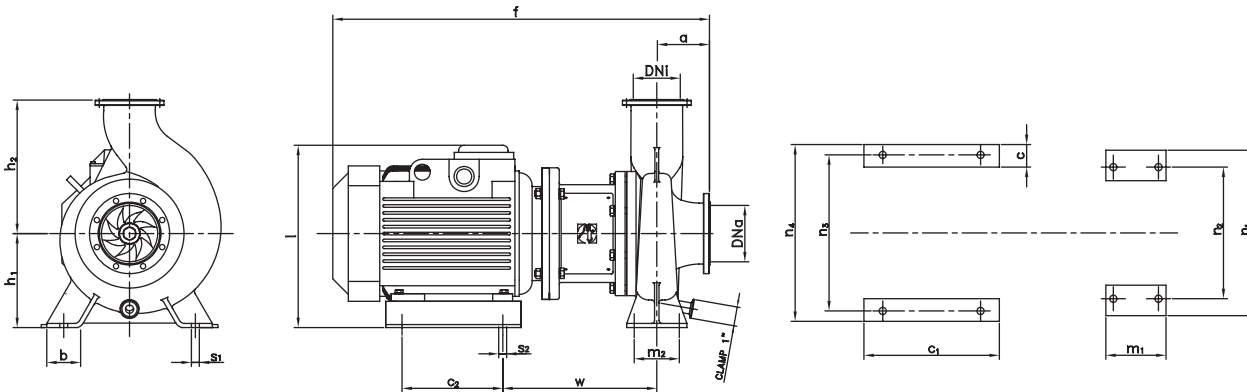

Pump	Motor	DNa	DNi	a	f	h ₁	h ₂	b	c	c ₁	c ₂	l	m ₁	m ₂	n ₁	n ₂	n ₃	n ₄	s ₁	s ₂	w	
125-100-250	160	125	100	121	850	316						460	160	120	440	350	415	470	18	18	18	342
	180				930							475										367
150-125-250	160	150	125	128	865	355	90	68	360	260		460	200	150	600	545	545	600	23	23	23	349
	180				945							475										374
200-150-250	180	200	150	142	965	340	68	88	400	305	585	475	210	150	600	545	545	600	23	23	23	381
	200				1005							585										384



The information is for guidance only. We reserve the right to modify any material or feature without notice in advance. Photos are not binding. For further information, please, consult our web site. www.inoxpa.com

