

NIKKISO EIKO



CHEMIPON

Serie BA, BZ

Leckagefreie Membran-Dosierpumpe

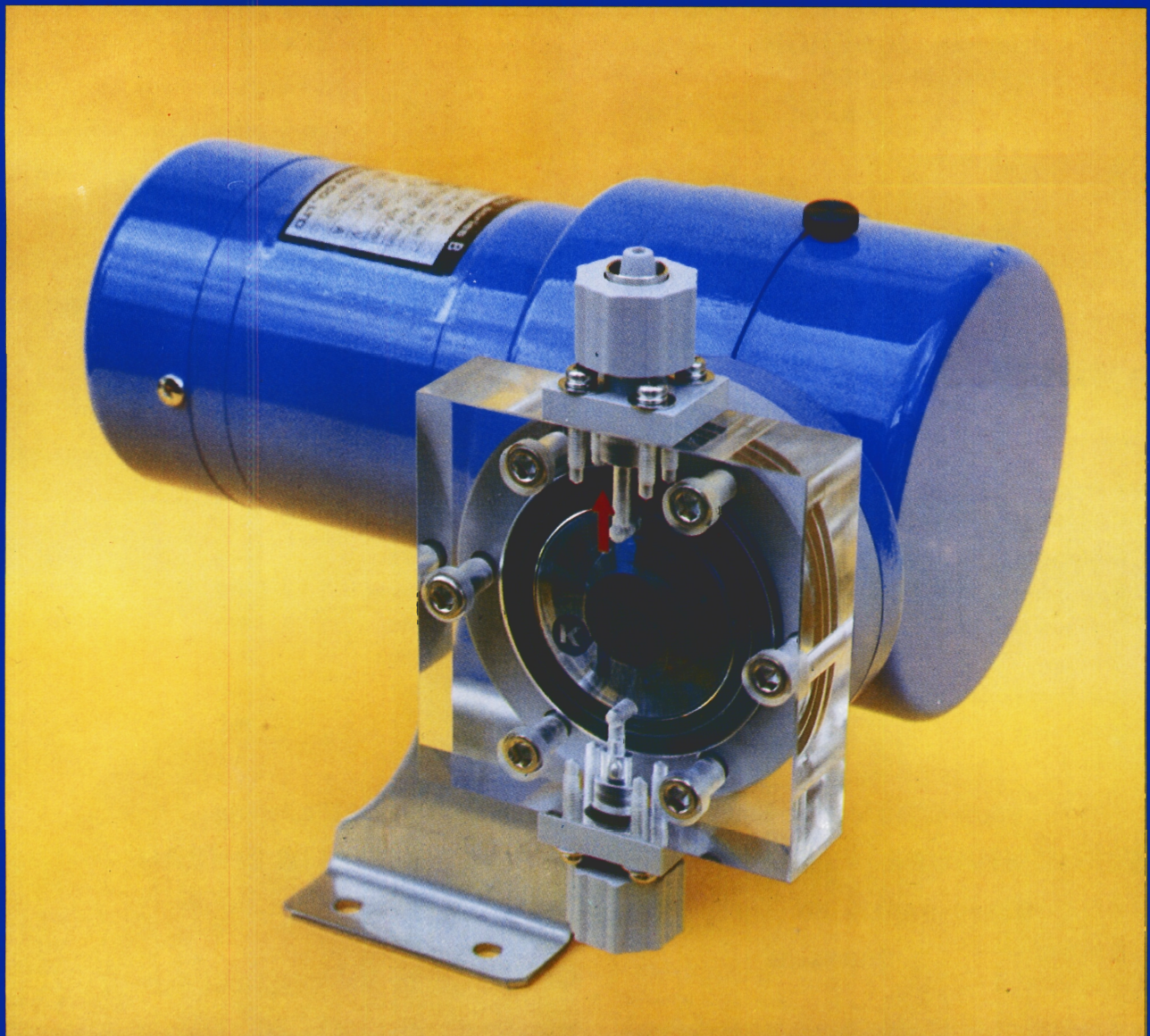



TECHNISCHE DATEN

MODELL	BA01	BA03	BA05	BA10	BA20	BA30	BA50	BZ1X	BZ3X	BZ5X
Max. Förderstrom (l/h) bei 0 bar Gegendruck	50 Hz 0,72	4,5	6,9	12,0	24,3	37,8	45,6	135	310	570
Max. Gegendruck (kgf/qcm)	10		15		10		7	5		
Fördermengenregelung	manuelle Hublängeneinstellung während des Stillstandes der Pumpe									
Anzahl der Hübe/min	50 Hz 43	40		78	120	160	315	200	350	
Max. Hublänge (mm)	1,6	2,8	4,8	5,6			3,2	6,8		
Motor	15 W			40 W			70 W	-		
	Wechselstrommotor mit Betriebskondensator 220 V, 50/60 Hz								Drehstrom	
ca. Gewicht (kg)	2,7	2,9	4,7			4,9	12,0	23 (ohne Motor)		

STANDARD ZUBEHÖR (für Standard-Modelle)

	BA 01 - 50	BZ1X	BZ3X 5X
Druckhalteventil	*	o	o
Fußventil	*	o	o
Sechskantschlüssel	*	*	-
Metallstifte zum Lösen der Sicherungsmutter	-	-	*
Saug-/Druckschlauch	*	-	-

* = serienmäßig enthalten
o = nur auf Wunsch erhältlich

EINSATZGEBIETE

- Dosierung von Chemikalien für die Wasser- und Abwasseraufbereitung
- Dosierung von Entkalkungs- und Rostschutzmitteln
- Dosierung von Reinigungs- und Sterilisationsmitteln für Rohrleitungen und Waschautomaten

WERKSTOFFE

Werkstoffe für Pumpenkopf	Standard			
	BA01 - 30	BA50	BA1X	BA3X, 5X
Membrane	FPM	FPM	FPM	PTFE
Pumpenkopf	PVC	PVC	PVC	PVC
Ventilsitze	FPM	FPM	FPM	PTFE
Ventilkugeln	Keramik	Keramik	HC	PTFE
Ventileinsätze	-	PVC	PVC	PTFE
Dichtungen	CSM	CSM	PTFE	PTFE
Saug-/Druckstutzen	PVC	PVC	PVC	PVC
Ventilgehäuse	-	-	PVC	PVC
Flansche	-	-	-	PVC

Die Pumpenköpfe für die Modelle **BA01 - 30** sind auf Wunsch auch in PTFE lieferbar.

PUMPENKOPF

Modell BA01 - 50

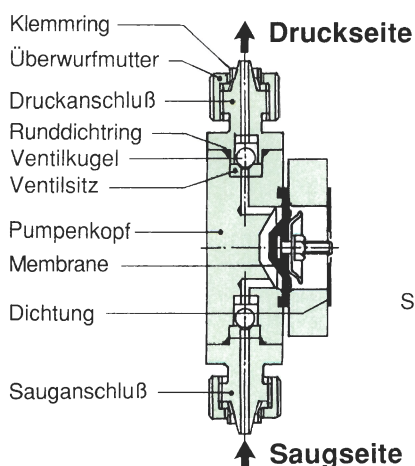

Modell BZ1X, 3X, 5X

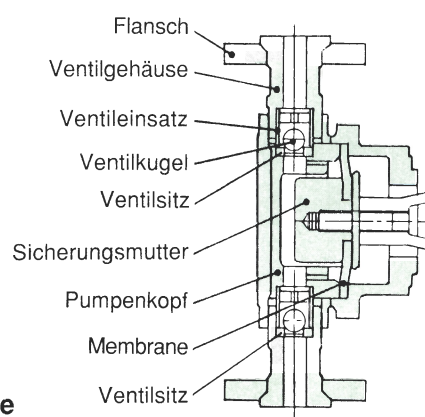

EINBAU

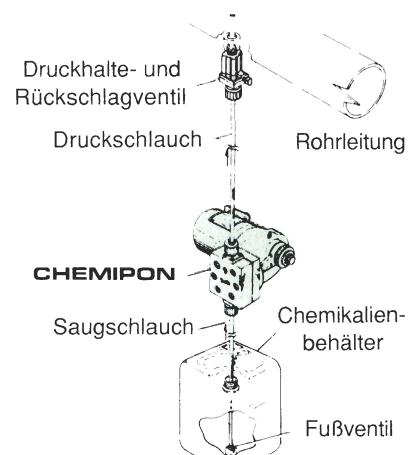

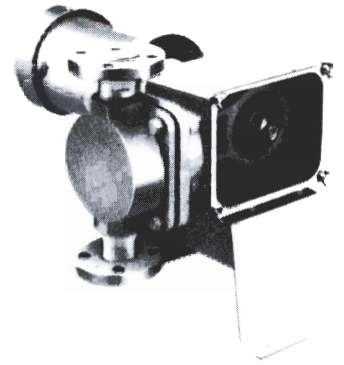
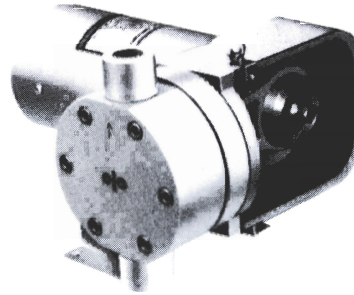
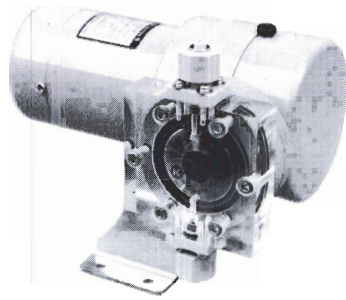
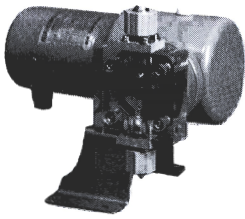

BA01 – 30

BA50

BZ1X

BZ3X, 5X

KENNLINIEN

bei 1m Saughöhe, Fördermedium: Wasser

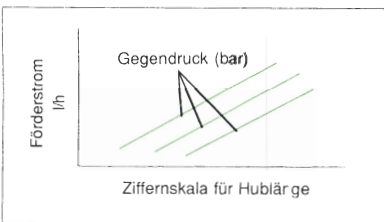

BA01

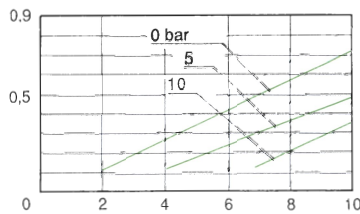

BA03

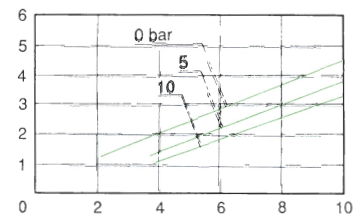

BA05

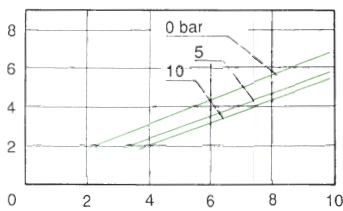

BA10

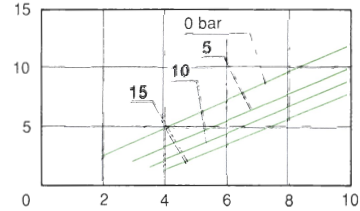

BA20

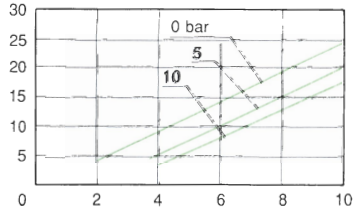

BA30

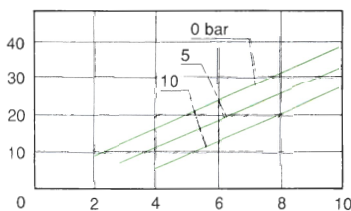

BA50

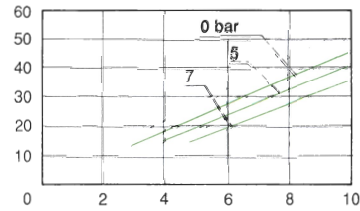

BZ1X

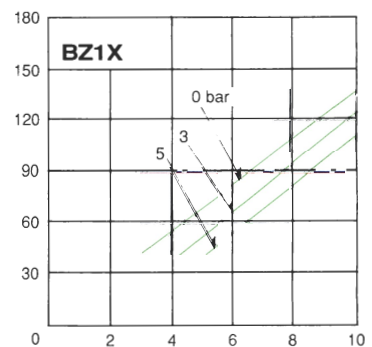

BZ3X



BZ5X

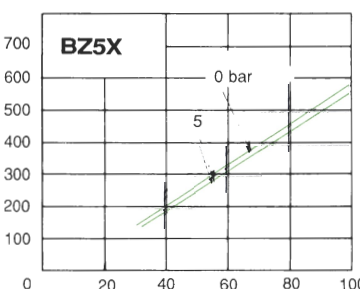

Anmerkung:

Die Pumpenmodelle BA01 – 50 sind, der besseren Darstellung des Innenaufbaus wegen, mit Pumpenköpfen aus Acrylglas abgebildet.

Standardmäßig werden die Pumpen jedoch mit Köpfen aus undurchsichtigem PVC geliefert

■ ABMESSUNGEN

• BA01, 03, 05, 10, 20, 30, 50

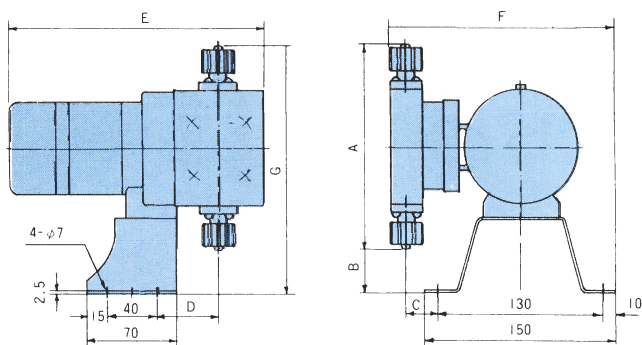

Druckhalte- u. Rückschlagventil

Mod. Nr. B22PV

Mat'l: PVC

Pumpe: BA01 – 30



Mod. Nr. B15PV

Mat'l: PVC

Pumpe: BA50



Mod. Nr. B06PV

Mat'l: PVC

Pumpe: BA01 – 30

Mod. Nr. B24PV

Mat'l: PVC

Pumpe: BA 50

Saug-/ Druckschlauch

Mat'l: PVC

6 x 11 mm Pumpe: BA01 – 30

9 x 15 mm Pumpe: BA50

• BZ1X

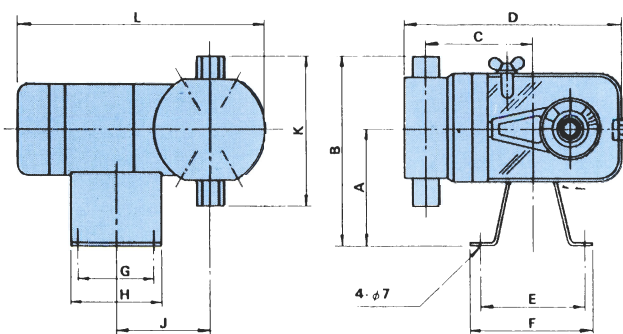

• BZ3X, 5X

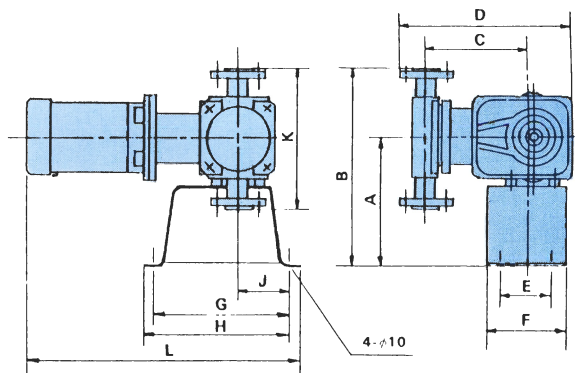

Modell	A	B	C	D	E	F	G	H	J	K	L
BA01	130	50	25	46	200	178	180				
BA03, 05	147	42	28	46	200	183	189				
BA10, 20, 30	160	40	37	56	235	190	200				
BA50	158	41	37	56	235	195	199				
BZ1X	140	246	131	265	130	150	90	110	104	212	260
BZ3X, 5X	235	363	186	326	100	150	260	290	100	256	510

 **NIKKISO EIKO CO., LTD.**

7 Fl., Kyoei-Seimi Ikek.-Bldg.
24-3 Higashi-Ikebukuro 4-chome
Toshima-Ku, Tokyo 170, Japan
TEL : 0081-3-5954-0711
FAX : 0081-3-5954-0716



NIKKISO Deutschland GmbH

Nikkisostraße
D-63674 Altstadt 2/ Hessen
Telefon : (0 60 47) 96 49-0
Telefax : (0 60 47) 96 49 99