











varisco[®]
solid pumping solutions





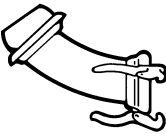
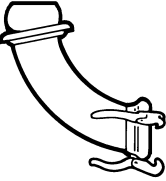



**Accessori per pompe e
impianti wellpoint**
**Accessories for pumps and
wellpoint system**
**Accessoires pour pompes et
équipements wellpoint**
**Accesorios para bombas y
instalaciones wellpoint**

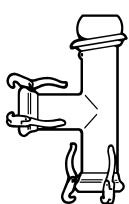



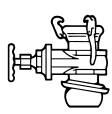
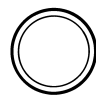
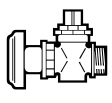

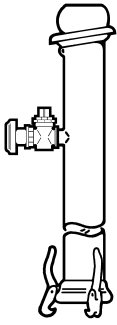
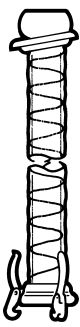
Descrizione Description Descripción	Image	Materiale Material Matériel Material	Note Notes Remarques Notas	Codice Code Code Código	Peso Weight Poids Peso [kg]	Lunghezza Length Longueur Longitud [mm]	Diametro Diameter Diamètre Diámetro		Connessioni Connections Connexions Conexiones	
							[mm / in]	[mm / in]	[mm]	[in]
N° 1 Raccordo portagomma maschio Male hose fitting Raccord mâle porte-tuyau Racor macho para manguera		Acciaio zincato Galvanized steel Acier galvanisé Acero galvanizado		10013367	0,4	110	40	50	2"	
				10013368	0,6	130	50	2"		
				10013369	0,8	140	60	3"		
				10013371	1,3	230	80	3"		
				10013374	1,7	280	100	4"		
				10013376	2,8	290	120	5"		
				10013377	3,5	295	150	6"		
				10013379	8	355	200	8"		
				10013380	12	400	250	10"		
				10013381	24	505	300	12"		
				10013349	0,8	105	40	2"		
				10013350	1,3	140	50	2"		
N° 2 Raccordo portagomma femmina Female hose fitting Raccord femelle porte-tuyau Racor hembra para manguera		Acciaio zincato Galvanized steel Acier galvanisé Acero galvanizado		10013351	1,4	150	60	80	3"	
				10013354	1,5	225	80	3"		
				10013357	2,0	240	80	4"		
				10013356	2,3	250	100	4"		
				10013359	3,0	255	120	5"		
				10013360	3,6	260	150	6"		
				10013363	9	300	200	8"		
				10013365	11	340	250	10"		
				10013366	25	440	300	12"		
				10013311	0,3	60	1 ¼"	2"		
				10013312	0,4	70	1 ½"	2"		
				N° 3 Raccordo maschio filettato Threaded male coupling Raccord mâle fileté Racor macho roscado		Acciaio zincato Galvanized steel Acier galvanisé Acero galvanizado		10013313	0,5	85
10013316	1,4	145	3"					80	3"	
10013318	1,9	150	4"					100	4"	
10013324	3,0	190	5"					120	5"	
10013326	3,5	170	5"					150	6"	
10018445	3,8	180	6"					150	6"	
10013302	0,7	75	1 ¼"					50	2"	
10013301	0,9	80	1 ½"					50	2"	
10013303	1	100	2"					80	3"	
10013304	1,7	110	3"					80	3"	
10013307	2,1	115	4"					100	4"	
10013308	3,2	125	5"					120	5"	
N° 4 Raccordo femmina filettato Threaded female coupling Raccord femelle fileté Racor hembra roscado		Acciaio zincato Galvanized steel Acier galvanisé Acero galvanizado		10013310	4	140	6"	150	6"	





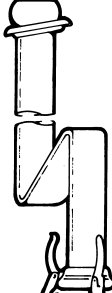
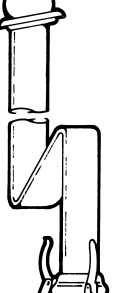

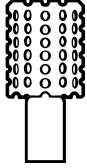
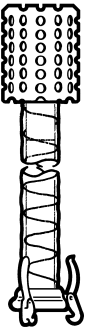
Descrizione Description Descripción	Image	Materiale Material Matériel Material	Note Notes Remarques Notas	Codice Code Code Código	Peso Weight Poids Peso [kg]	Lunghezza Length Longueur Longitud [mm]	Diametro Diameter Diamètre Diámetro [mm / in]	Connections Connexions Conexiones	
								[mm]	[in]
N° 5 Raccordo maschio flangiato Flanged male coupling Raccord mâle bridé Racor de brida macho		Acciaio zincato Galvanized steel Acier galvanisé Acero galvanizado	**EN 1092-1 PN 10/16 *Ø 150 fresato with cut avec couronne tronquée fresado	10013331	1,5	50		50	2"
				10013314	5	100		80	3"
				10013332	6	120		100	4"
				10013335	8	180			
				**10013336	10	205		150	6"
				*10013338	8	180		200	8"
				10013344	10	255		250	10"
				10013347	20	315		300	12"
				10013348	30	380			
				10013396	2,5			80	3"
N° 6 Curva a 45° 45° elbow Coude 45° Curva 45°		Acciaio zincato Galvanized steel Acier galvanisé Acero galvanizado		10013397	3,4			100	4"
				10013398	4,5			120	5"
				10013399	6			150	6"
				10013401	15			200	8"
				10013402	22			250	10"
				10013404	1,7			50	2"
				10013405	2,7		2 leve / levers 2 leviers / palacas	80	3"
				10013407	4			100	4"
				10013409	7			120	5"
				10013410	7,5			150	6"
N° 7 Curva a 90° 90° elbow Coude 90° Curva 90°		Acciaio zincato Galvanized steel Acier galvanisé Acero galvanizado		10022355	16			200	8"
				10047781	24		3 leve / levers 3 leviers / palacas	250	10"
				10013419	42			300	12"
				10013462	1,4			100	4"
				10013463	2			120	5"
				10013464	2,9			150	6"
				10013465	7			200	8"
				10021960	11			250	10"
				10013455	0,3			50	2"
				10013457	1,4			100	4"
N° 8 Tappo maschio Male cap Bouchon mâle Tapón macho		Acciaio zincato Galvanized steel Acier galvanisé Acero galvanizado		10013458	1,9			120	5"
				10013459	2,3			150	6"
				10013460	7			200	8"
				10021959	11			250	10"
				10013455	0,3			50	2"
				10013457	1,4			100	4"
				10013458	1,9			120	5"
				10013459	2,3			150	6"
				10013460	7			200	8"
				10021959	11			250	10"
N° 9 Tappo femmina Female cap Bouchon femelle Tapón hembra		Acciaio zincato Galvanized steel Acier galvanisé Acero galvanizado		10002383	0,2			32	1 1/4"
				10002383	0,2			32	1 1/4"
				10002383	0,2			32	1 1/4"
				10002383	0,2			32	1 1/4"
				10002383	0,2			32	1 1/4"
				10002383	0,2			32	1 1/4"
				10002383	0,2			32	1 1/4"
				10002383	0,2			32	1 1/4"
				10002383	0,2			32	1 1/4"
				10002383	0,2			32	1 1/4"
N° 10 Tappo filettato / Threaded plug Bouchon fileté / Tapón roscado		Acciaio zincato Galvanized steel Acier galvanisé Acero galvanizado		10002383	0,2			32	1 1/4"
				10002383	0,2			32	1 1/4"
				10002383	0,2			32	1 1/4"
				10002383	0,2			32	1 1/4"
				10002383	0,2			32	1 1/4"
				10002383	0,2			32	1 1/4"
				10002383	0,2			32	1 1/4"
				10002383	0,2			32	1 1/4"
				10002383	0,2			32	1 1/4"
				10002383	0,2			32	1 1/4"

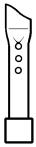

Descrizione Description Description	Immagine	Materiale Material Matériel Material	Note Notes Remarques Notas	Codice Code Code Código	Peso Weight Poids Peso	Lunghezza Length Longueur Longitud	Diametro Diameter Diamètre Diámetro	Connesioni Connections Connexions Conexiões	
								[mm]	[in]
N° 11 Raccordo a "T" femmina/femmina/maschio Female/female/male "T" fitting Raccord a "T" femelle/femelle/mâle Racor "T" hembra/hembra/macho		Acciaio zincato Galvanized steel Acier galvanisé Acero galvanizado		10013449	6,5			100	4"
				10013450	8			120	5"
				10013452	10	-		150	6"
				10013453	26			200	8"
				10013454	32			250	10"
N° 12 Raccordo inversione maschio/maschio Male/male inverter coupling Raccord inversion mâle/mâle Racor inversión macho/macho		Acciaio zincato Galvanized steel Acier galvanisé Acero galvanizado		10013422	1			50	2"
				10013424	2,2			100	4"
				10018441	3,4	-		120	5"
				10013425	4,5			150	6"
				10013426	1,3			50	2"
N° 13 Raccordo inversione femmina/femmina Female/female inverter coupling Raccord inversion femelle/femelle Racor inversión hembra/hembra		Acciaio zincato Galvanized steel Acier galvanisé Acero galvanizado		10013428	3,3			100	4"
				10013429	4	-		120	5"
				10013430	5			150	6"
				10013434	3,5			100	4"
				10013435	4,8			120	5"
N° 14 Riduzione maschio/femmina Male/female reducer Raccord reducteur mâle/femelle Reducción macho/hembra		Acciaio zincato Galvanized steel Acier galvanisé Acero galvanizado		10013436	5,5	-	100	150	6"
				10013437	5,5		120		
				10018442	8		150		
				10018444	13		150		
				10013431	3,6		100		
N° 15 Saracinesca maschio/femmina Male/female gate valve / Vanne mâle/femelle Válvula de compuerta macho/hembra		Acciaio zincato Galvanized steel Acier galvanisé Acero galvanizado		10013684	5,5			80	3"
				10016741	9			100	4"
				10013685	10	-		120	5"
				10018447	14			150	6"
				10013049	0,02			50	2"
N° 16 Guarnizione O- ring Joint Junta tórica		Gomma NBR NBR rubber Caoutchouc NBR Caucho NBR		10013051	0,05			80	3"
				10013052	0,07			100	4"
				10013053	0,1			120	5"
				10013054	0,15	-		150	6"
				10013056	0,28			200	8"
N° 17 Presca completa / Cock assembly Robinet complet / Grifo completo		Ottone / Brass Laiton / Latón		10013057	0,47			250	10"
				10013058	0,67			300	12"
				10013660	1,5	-		32	1 1/4"

Descrizione Description Description Descripción	Immagine	Materiale Material Matériel Material	Note Notes Remarques Notas	Codice Code Code Código	Peso Weight Poids Peso [kg]	Lunghezza Length Longueur Longitud [m]	Connessioni Connections Connexions Conexiones	
							[mm]	[in]
N° 25 Collettore con prese complete Header pipe complete with cock assemblies Tuyau collecteur avec robinets Colector con grifos completos		Acciaio zincato Galvanized steel Acier galvanisé Acero galvanizado	N° 3 - 1 1/4" N° 6 - 1 1/4" N° 3 - 1 1/4" N° 4 - 1 1/4" N° 6 - 1 1/4" N° 3 - 1 1/4" N° 4 - 1 1/4" N° 6 - 1 1/4"	10018691	16,5	5,8	100	4"
				10048941	17,5	6,2	100	4"
				10051210	24,0	5,8	100	4"
				10051212	25,0	6,2	100	4"
				10013654	21	4,0	120	5"
				10018449	28,5	5,8	120	5"
				10048940	30	6,2	120	5"
				10013655	31,5	5,8	120	5"
				10048937	33	6,2	120	5"
				10013657	27	4,0	150	6"
N° 26 Tubo flessibile (PVC con spirale in acciaio) Flexible hose (PVC with steel spiral) Tuyau flexible (PVC avec spire d'acier) Tubo flexible (PVC con espiral de acero)		PVC	Vuoto max Max vacuum Vide max Vacío max	10013539	9,5	4	50	2"
				10013540	12,5	6	50	2"
				10013541	18	10	80	3"
				10013549	9	2	80	3"
				10013550	17	4	80	3"
				10013551	19,5	5	80	3"
				10013552	23	6	80	3"
				10013561	53	2	100	4"
				10013563	22	4	100	4"
				10013564	26	5	100	4"
10013565	30	6	100	4"				
10015784	10	10	120	5"				
N° 28 Tubo flessibile (Gomma / tela con spirale in acciaio) Flexible hose (Rubber / canvas with steel spiral) Tuyau flexible (Caoutchouc/toile avec spire d'acier) Tubo flexible (Caucho / tela con espiral de acero)		Gomma / tela Rubber / canvas Caoutchouc / toile Caucho / tela	Vuoto max Max vacuum Vide max Vacío max	10013570	16,5	2	120	5"
				10013572	20	3	120	5"
				10013571	27	4	120	5"
				10018452	38,5	6	120	5"
				10013573	22,5	2	120	5"
				10013580	29,5	3	120	5"
				10013575	39	4	120	5"
				10013576	47,5	5	120	5"
				10013577	55	6	120	5"
				10013581	42	2	120	5"
10013582	67	4	120	5"				
10018460	79	5	120	5"				
10013583	92	6	120	5"				
10013585	64	2	120	5"				
10016001	77	3	120	5"				
10013586	103	4	120	5"				
10013587	124	5	120	5"				
10013588	153	6	120	5"				
10013591	75	2	120	5"				
10018811	112,5	3	120	5"				
10013592	150	4	120	5"				

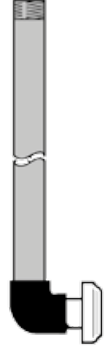
Descrizione Description Descripción	Image	Materiale Material Matériel Material	Note Notes Remarques Notas	Codice Code Code Código	Peso Weight Poids Peso	Lunghezza Length Longueur Longitud	Pressione Pressure Pression Presión	Connesioni Connections Connexions Conexiones		
								[mm]	[in]	
N° 29 Manichetta di mandata Flat discharge hose Tuyau de refoulement Manguera de descarga		PVC / tela		10012918	0,32/m		8	40	1 ½"	
		PVC / canvas		10012919	0,41/m		10	50	2"	
		PVC / toile		10012920	0,56/m		8	60	2 ½"	
		PVC / tela		10012921	0,77/m		8	80	3"	
				10012922	1,05/m		8	100	4"	
				10012923	1,28/m		6	127	5"	
				10012924	1,60/m		4	150	6"	
				10012925	2,40/m		2,5	204	8"	
				10012926	1,30/m		5	250	10"	
				10012927	2,10/m		5	300	12"	
N° 30 Manichetta di mandata con raccordo femmina Flat discharge hose with female coupling Tuyau de refoulement avec raccord femelle Manguera de descarga con racor hembra		PVC / tela		10013597	4,3	10	10	40	1 ½"	
		PVC / canvas		10018651	7,5	10	10	50	2"	
		PVC / toile		10013606	9	10	10	8	80	3"
		PVC / tela		10013611	11	10	10	4	100	4"
				10018652	14	10	6	127	5"	
				10015378	23,5	10	4	150	6"	
				10015399	28	10	2,5	204	8"	
				10018653	39,5	10	5	250	10"	
				10018654	76	10	5	300	12"	
				10013620	5,5	10	8	40	1 ½"	
N° 31 Manichetta di mandata con raccordi maschio/femmina Flat discharge hose with male/female couplings Tuyau de refoulement avec raccords mâle/femelle Manguera de descarga con racores macho/hembra		PVC / tela		10013621	8	10	10	50	2"	
		PVC / canvas		10013623	8	10	16	80	3"	
		PVC / toile		10013631	11,5	10	8	80	3"	
		PVC / tela		10013638	14,5	10	8	100	4"	
			2 leve / levers 2 leviers / palacas	10013637	15	10	8	100	4"	
			3 leve / levers 3 leviers / palacas	10018317	18	10	6	127	5"	
				10013648	23	10	4	150	6"	
				10013653	41	10	2,5	204	8"	
				10013590	64	10	5	250	10"	
				10013593	168	10	5	300	12"	
N° 31.1 Manichetta di infissione con raccordi maschio/femmina Jetting hose with male/female couplings Tuyau de lançage avec raccords mâle/femelle Manguera hincado con racores macho/hembra		Gomma / tela Rubber / canvas Caoutchouc / toile Caucho / tela		10018699	11	10	10	50	2"	

Descrizione Description Description Descripción	Immagine	Materiale Material Matériel Material	Note Notes Remarques Notas	Codice Code Code Código	Peso Weight Poids Peso [kg]	Lunghezza Length Longueur Longitud [m]	Conessioni Connections Connexions Conexiones	
							[mm]	[in]
N° 32 Filtro di fondo Strainer Crépine Filtro de fondo		Acciaio zincato Galvanized steel Acier galvanisé Acero galvanizado		10013242	0,67	0,200	40	1 ½"
				10013243	0,95	0,240	50	2"
				10013246	1,95	0,320	80	3"
				10013247	2,87	0,440	100	4"
				10013248	4,5	0,550	120	5"
				10013249	8	0,640	150	6"
				10013252	15,5	0,810	200	8"
				10013227	1,7	0,210	50	2"
				10013228	2,8	0,320	80	3"
				10013229	5	0,450	100	4"
				10013230	7,5	0,610	120	5"
				10013231	10,5	0,700	150	6"
				10013234	22	0,910	200	8"
10013235	90	1,190	250	10"				
10013237	140	1,840	300	12"				
N° 34 Tubo di aspirazione flessibile con filtro (PVC con spirale in acciaio) Flexible suction hose with strainer (PVC with steel spiral) Tuyau flexible d'aspiration avec crépine (PVC avec spire d'acier) Tubo de aspiración flexible con filtro (PVC con espiral de acero)		PVC + Acciaio zincato PVC + Galvanized steel PVC + Acier galvanisé PVC + Acero galvanizado		10013495	9,5	4	50	2"
				10013496	11	6	60	2 ½"
				10013497	12,5	6	80	3"
				10013503	15	6	100	4"
				10013506	17,5	6	120	5"
				10013507	20,5	6	150	6"
				10013508	24	6	200	8"
				10013520	22,5	6	250	10"
				10013521	26,5	6	300	12"
				10013522	31	6	400	16"
				10017849	30	4	120	5"
				10015729	38	6	150	6"
				10013530	28	2	80	3"
10029782	30	3	100	4"				
10013529	44	4	150	6"				
10013527	52	5	200	8"				
10013528	60	6	250	10"				
10013534	73,5	4	300	12"				
10013535	99,5	6	400	16"				
N° 37 Punta filtrante (telaio in alluminio, guaina filtrante inox reps) Wellpoint spear (aluminium frame, reps stainless steel screen) Pointe filtrante (châssis en aluminium, gaine filtrante en acier inox reps) Punta de filtración (bastidor de aluminio, vaina de filtración inoxidable reps)		Alluminio + Acciaio inox Aluminium + Stainless steel Aluminium + Acier inoxydable Aluminio + Acero inoxidable		10013671	1,7	0,650	32	1 ¼"

Descrizione Description Description	Immagine	Materiale Material Matériel Material	Note Notes Remarques Notas	Codice Code Code Código	Peso Weight Poids Peso [kg]	Lunghezza Length Longueur Longitud [m]	Conessioni Connections Connexions Conexiones	
							[mm]	[in]
N° 39 Punta filtrante per ghiaia Wellpoint spear for gravel Pointe filtrante pour gravillon Punta de filtración para gravilla		Alluminio Aluminium Aluminium Aluminio		10013682	1,7	0,350	32	1 ¼"
N° 44 Tubo di sollevamento + punta filtrante (Rif. 37) Riser pipe + wellpoint spear (Ref. 37) Tuyau de soulèvement + pointe filtrante (Réf. 37) Tubo de elevación + punta de filtración (Ref. 37)		Alluminio + Acciaio Aluminium + Steel Aluminium + Acier Aluminio + Acero		10013680	10	3	32	1 ¼"
				10013681	12,5	4		
				10018701	15	5		
				10017024	17,5	6		
N° 45 Tubo di sollevamento + punta filtrante per ghiaia Riser pipe + wellpoint spear for gravel Tuyau de soulèvement + pointe filtrante pour gravillon Tubo de elevación + punta de filtración para gravilla		Alluminio + Acciaio Aluminium + Steel Aluminium + Acier Aluminio + Acero		10016932	10	3	32	1 ¼"
				10016798	12,5	4		
				10013683	15	5		
				10018669	17,5	6		
N° 46 Tubo di sollevamento Riser pipe Tuyau de soulèvement Tubo de elevación		PVC		10045490	3	2	32	1 ¼"
				10045491	4,5	3		
				10045492	5,5	4		
				10045493	7	5		
				10045494	8	6		
				10045226	3	2		
N° 47 Tubo di sollevamento con gomito Riser pipe with elbow Tuyau de soulèvement avec coude Tubo de elevación con codo		PVC		10045225	4	3	32	1 ¼"
				10044480	5	4		
				10044479	6,5	5		
				10044481	9	6		
				10045226	3	2		
N° 48 Punta filtrante / Wellpoint spear Pointe filtrante / Punta de filtración		PVC + PE HD		10044478	0,7	-	32	1 ¼"
				10045224	3,4	2		
N° 49 Tubo di sollevamento con gomito e punta filtrante Riser pipe with elbow and wellpoint spear Tuyau de soulèvement avec coude et pointe filtrante Tubo de elevación con codo y punta de filtración		PVC + PE HD		10045223	4,6	3	32	1 ¼"
				10044483	6	4		
				10044482	7	5		
				10044484	8,5	6		

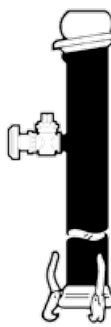
Descrizione Description Descripción	Disegno Drawing Dibujo	Materiale Material Matériel Material	Note Notes Remarques Notas	Codice Code Code Código	Peso Weight Poids Peso [kg]	Lunghezza Length Longueur Longitud [m]	Connessioni Connections Connexions Conexiones	
							[mm]	[in]
N° 50 Tubo di scarico con raccordi Discharge pipe with couplings Tuyau de refoulement avec raccords Tubo de descarga con racores		PE HD		10045076	10	3,0	100	4"
				10045075	12	4,0	100	4"
				10045074	16	5,8	100	4"
				10045236	12,5	4,0	120	5"
				10045237	15,5	5,8	120	5"
				10045238	18,5	4,0	150	6"
N° 51 Collettore con 3 attacchi Header pipe with 3 threaded holes Tuyau collecteur avec 3 prises pour robinet Colector con 3 conexiones		PE HD	N° 3 - 1 1/4"	10044487	6,5	5,8	100	4"
				10045241	10,5	4,0	120	5"
				10045242	17	4,0	150	6"
				10044486	17,5	5,8	120	5"
				10044485	27,5	5,8	150	6"
				10044488	10	5,8	100	4"
N° 52 Collettore con 6 attacchi Header pipe with 6 threaded holes Tuyau collecteur avec 6 prises pour robinet Colector con 6 conexiones		PE HD	N° 6 - 1 1/4"	10044486	17,5	5,8	120	5"
				10044485	27,5	5,8	150	6"
				10044488	10	5,8	100	4"
				10045245	15	4,0	120	5"
				10045246	21	4,0	150	6"
				10044489	25	5,8	120	5"
N° 54 Collettore con 6 prese complete Header pipe with 6 cock assemblies Tuyau collecteur avec 6 robinets Colector con 6 grifos completos		PE HD	N° 6 - 1 1/4"	10044489	25	5,8	120	5"
				10044490	33	5,8	150	6"
				10044488	10	5,8	100	4"
				10045245	15	4,0	120	5"
				10045246	21	4,0	150	6"
				10044489	25	5,8	120	5"

ACCESSORI STANDARD PER POMPE / STANDARD PUMP ACCESSORIES
ACCESSOIRES STANDARD POUR POMPES / ACCESORIOS ESTÁNDARES PARA BOMBAS

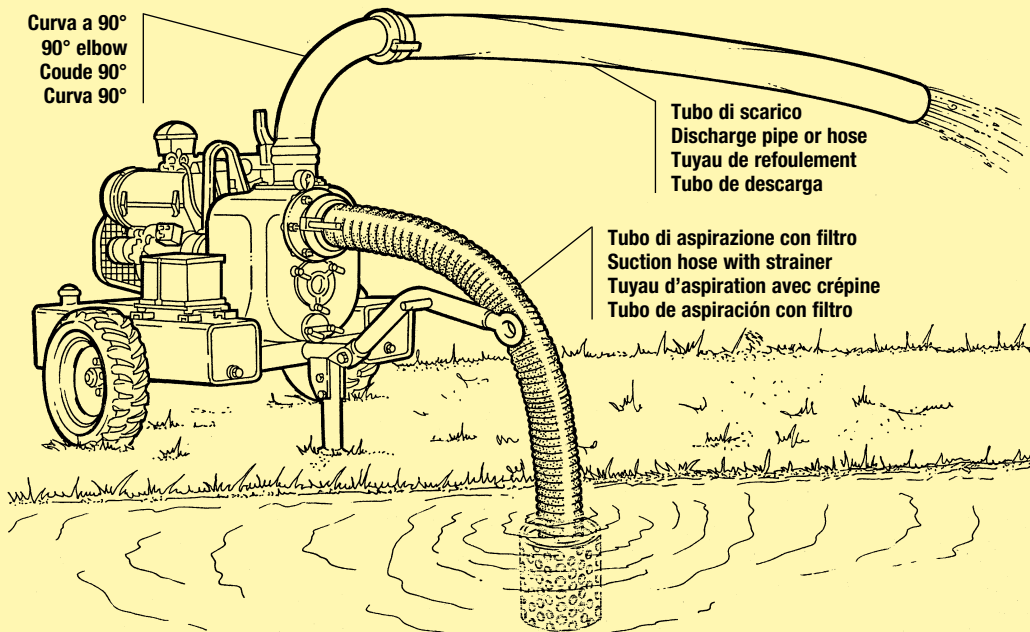

IMPIANTO WELLPOINT STANDARD / STANDARD WELLPOINT SYSTEM
ÉQUIPEMENT WELLPOINT DE SÉRIE / INSTALACIÓN WELLPOINT ESTÁNDAR

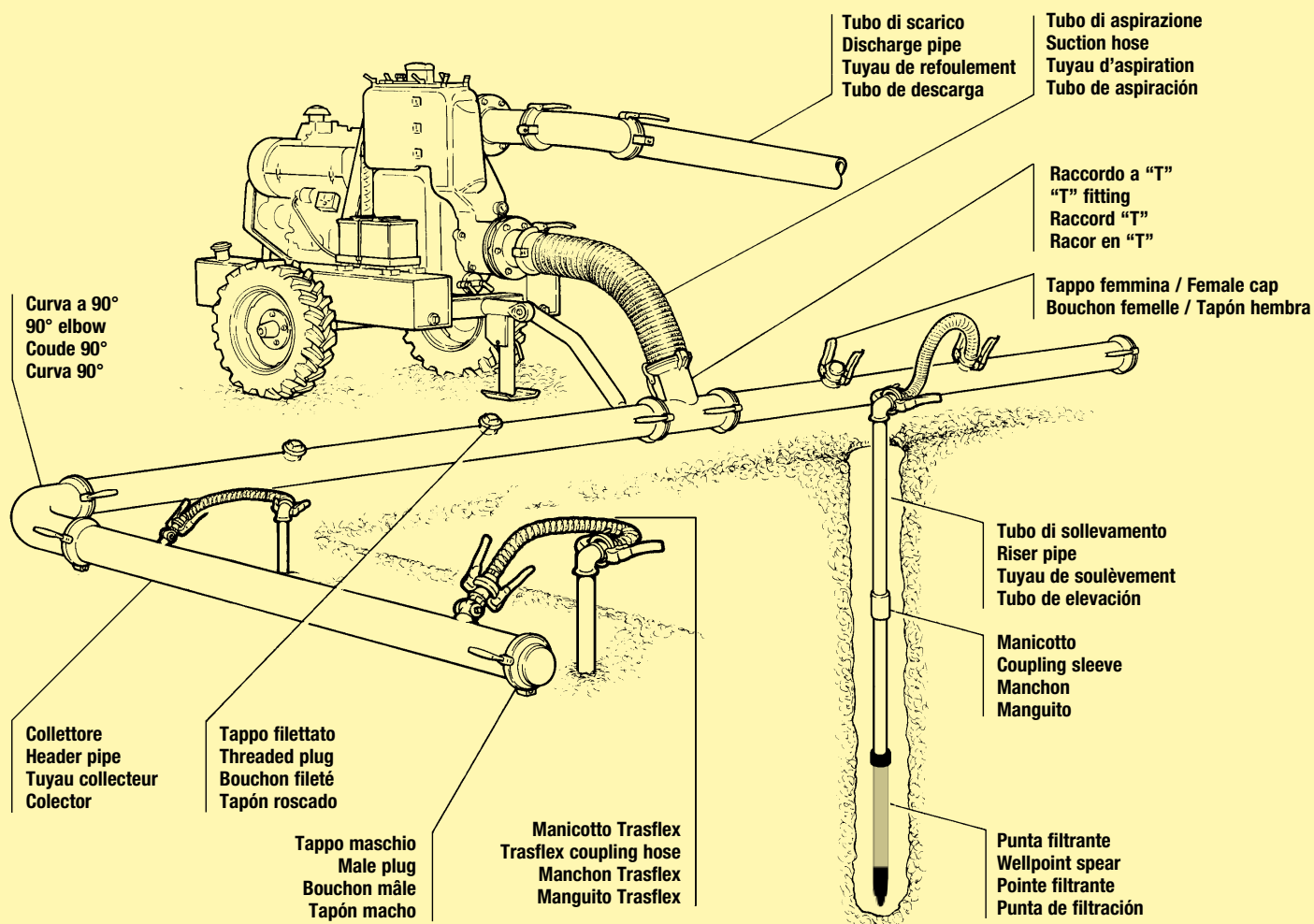

VARISCO S.p.A.

variscospa.com

**Terza Strada, 9 - Z.I. Nord
35129 PADOVA - Italy
Tel. +39 049 82 94 111
Fax +39 049 82 94 373**

**Vendite Italia
Tel. 049 82 94 111
Fax 049 82 94 373
italia@variscospa.com**

**International sales
Tel. +39 049 82 94 111
Fax +39 049 80 76 762
export@variscospa.com**

**EN ISO 9001 : 2008
Reg. No. 44 100 091767**

