

Industrial Peristaltic pumps

AMP-10B Dimensions

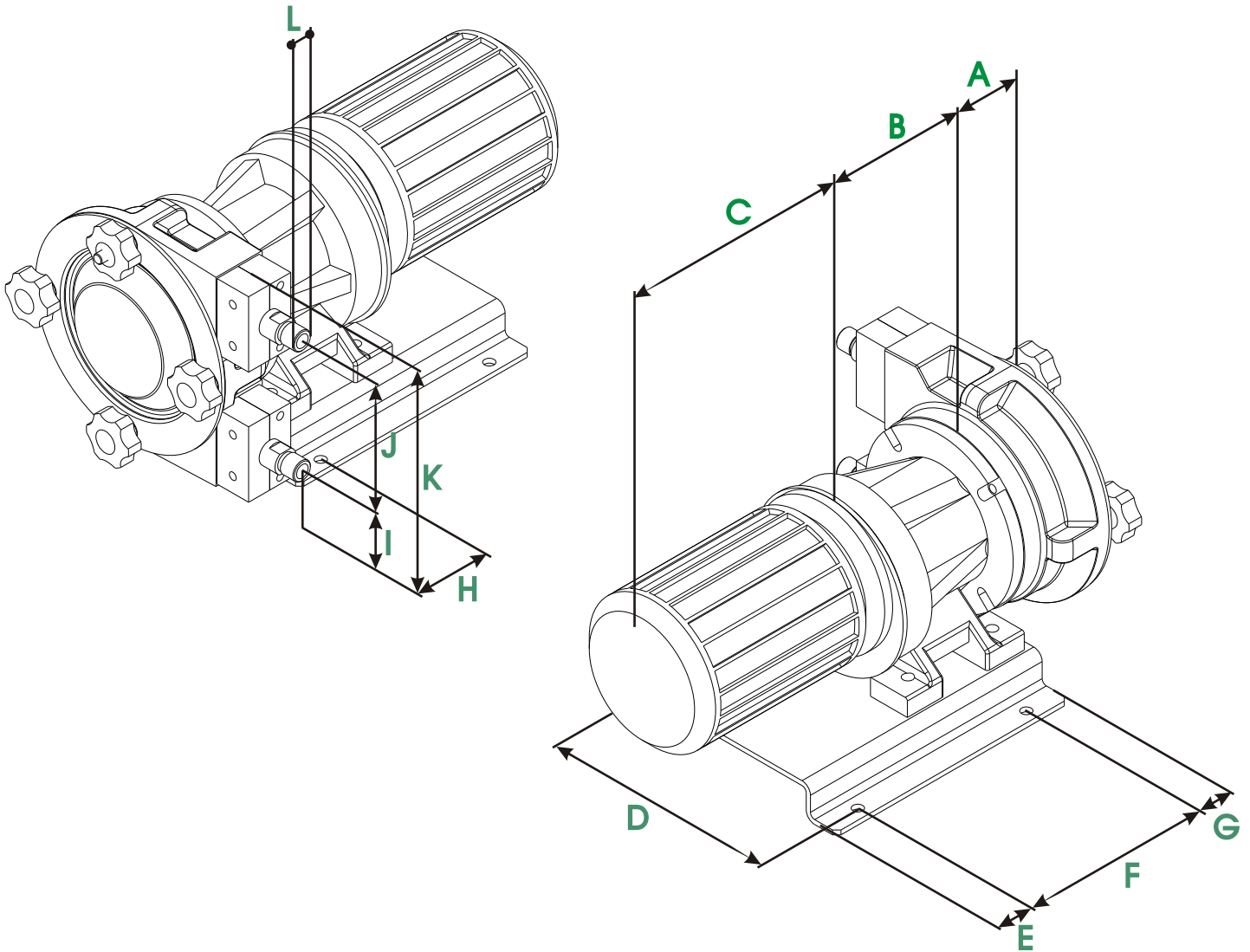

A	B	C	D	E	F	G	H	I	J	K	L
70	*	*	190	30	160	30	61	60	115	210	3/8" BSP

* To confirm according type and power driver.