

Industrial peristaltic Pumps

FMP-50 Dimensions

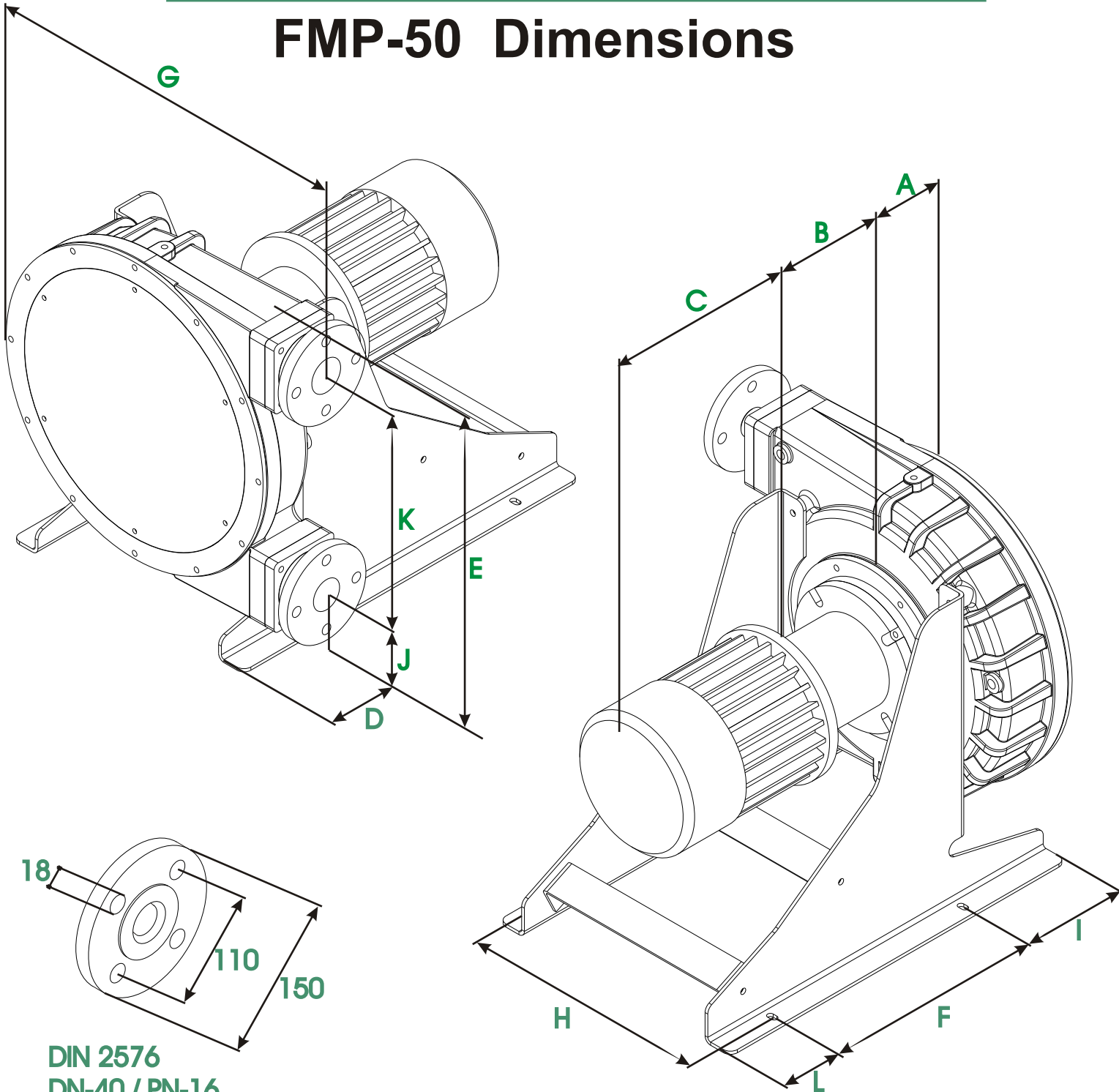

DIN 2576
DN-40 / PN-16

A	B	C	D	E	F	G	H	I	J	K	L
151	*	*	79	645	415	633	453	200	159	412	115

* To confirm according type and power driver.