

POMPA PER VUOTO AD ANELLO LIQUIDO

LIQUID RING VACUUM PUMP

AL1305A

MODELLO AL1305A



La pompa per vuoto ad anello liquido modello AL1305A è del tipo monostadio con valvola, in esecuzione ad asse nudo. Compatta, versatile nelle prestazioni, raggiunge 33mbar ass., adatta ad aspirare vapori e gas con tracce di liquidi, non necessita di lubrificazione, manutenzione contenuta. Disponibile in esecuzione standard in acciaio inox. A scelta tenute a baderna o meccaniche.

The liquid ring vacuum pump model AL1305A is single stage type fitted with vary port valve, bareshaft version. Compact, flexible in performance, achieves 33 mbar abs., suitable to suck vapors and gas with liquid carry over, oil free operation, limited maintenance required. Available in standard version or in stainless steel. Option for gland packing or mechanical seals.

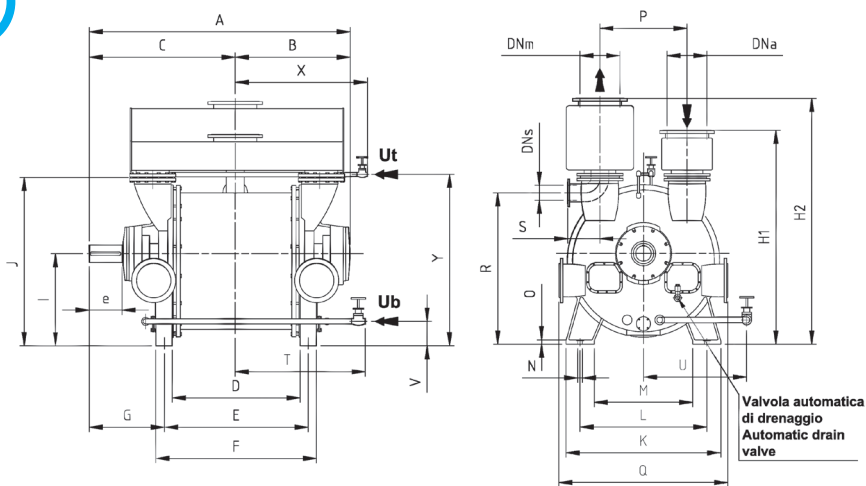

Emmecom s.r.l.

Via P. Nenni, 70
20093 Cologno Monzese (MI)
Tel. +39 02 25 33 300 (r.a.)
Fax +39 02 27 307 908
www.emmecomsrl.com
sales@emmecomsrl.com



	A	B	C	D	E	F	G	H1	H2	I	J	K	L	M	N	O	P	Q	R	S	T	U	V	X	Y	Peso totale - Kg Total Weight - Kg
AL1305A	1695	1245	450	795	900	1005	480	1185	1360	475	910	960	670	470	35	25	460	960	825	205	997	465	137	870	1100	1500

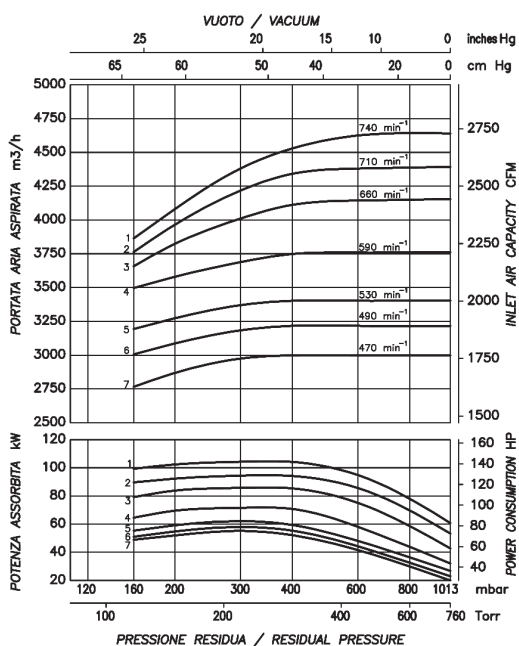

DNa	200 - 8"	Attacco aspirazione Suction nozzle
DNm	200 - 8"	Attacco mandata Discharge nozzle
DNs	100 - 4"	Attacco scarico Water discharge nozzle
Ub	G 1" 1/2	Attacco per liquido di esercizio Service liquid connection
Ut	G 3/4"	Attacco flussaggio esterno tenuta (se richiesto) External seal flushing (if requested)
d	100	Ø Albero - Shaft

I valori di portata sono riferiti ad aria saturata, alla temperatura di 20°C, alla pressione atmosferica di mandata (1013 mbar), e all'impiego di acqua alla temperatura di 15°C. Tolleranza di prestazione ± 10%. Nell'esecuzione in inox la portata diminuisce del 5%. I dati sopraindicati possono essere variati senza preavviso.

The given capacity values are referred to saturated air at the temperature of 20°C, atmospheric discharge pressure (1013 mbar), and of supply of service water at 15°C temperature. Performance tolerance ± 10%. Stainless steel construction is 5% less performing. The data may change without any notice.

a i r m o v i n g