

POMPA PER VUOTO AD ANELLO LIQUIDO

LIQUID RING
VACUUM PUMP

AL1603A

MODELLO AL1603A



La pompa per vuoto ad anello liquido modello AL1603A è del tipo monostadio con valvola, in esecuzione ad asse nudo. Compatta, versatile nelle prestazioni, raggiunge 33mbar ass., adatta ad aspirare vapori e gas con tracce di liquidi, non necessita di lubrificazione, manutenzione contenuta. Disponibile in esecuzione standard o in acciaio inox. A scelta tenute a baderna o meccaniche.

The liquid ring vacuum pump model AL1603A is single stage type fitted with vary port valve, bareshaft version. Compact, flexible in performance, achieves 33 mbar abs., suitable to suck vapors and gas with liquid carry over, oil free operation, limited maintenance required. Available in standard version or in stainless steel. Option for gland packing or mechanical seals.

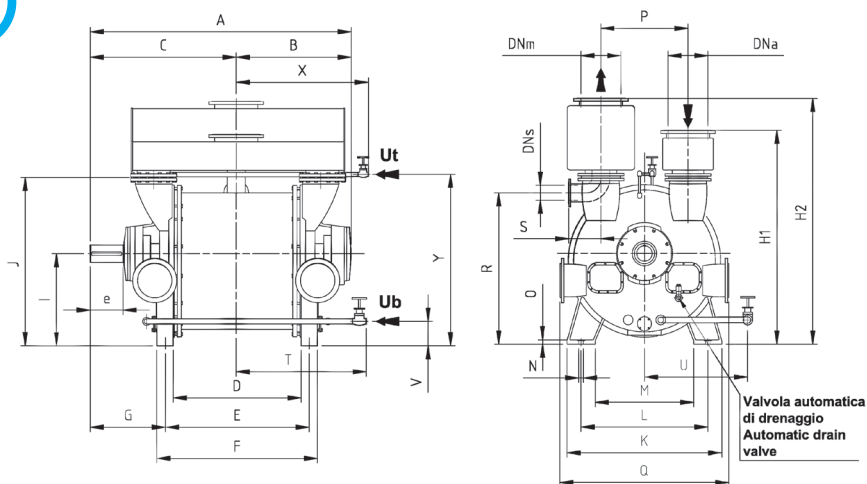

Emmecom s.r.l.

Via P. Nenni, 70
20093 Cologno Monzese (MI)
Tel. +39 02 25 33 300 (r.a.)
Fax +39 02 27 307 908
www.emmecomsrl.com
sales@emmecomsrl.com



	A	B	C	D	E	F	G	H1	H2	I	J	K	L	M	N	O	P	Q	R	S	T	U	V	X	Y	Peso totale - Kg Total Weight - Kg
AL1603A	2510	1130	1380	1305	1480	1655	640	2220	2560	950	1770	1750	1320	1020	48	42	870	1750	1555	370	365	990	244	1313	1825	7500

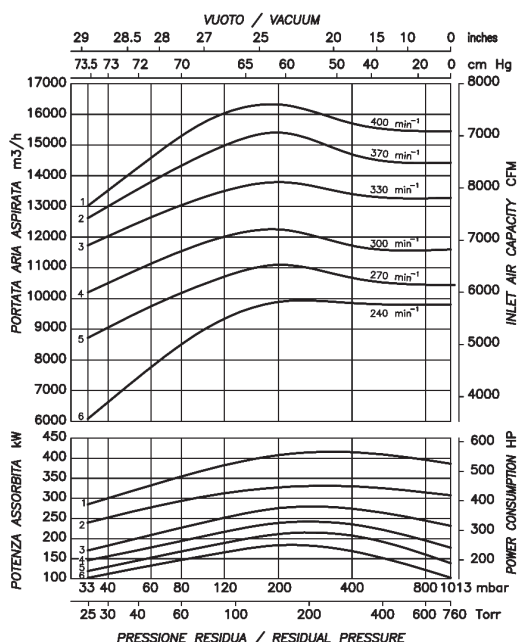

DNa	400 - 16"	Attacco aspirazione Suction nozzle
DNm	400 - 16"	Attacco mandata Discharge nozzle
DNs	200 - 8"	Attacco scarico Water discharge nozzle
Ub	DN 80	Attacco per liquido di esercizio Service liquid connection
Ut	DN 25	Attacco flussaggio esterno tenuta (se richiesto) External seal flushing (if requested)
d	180	Ø Albero - Shaft

I valori di portata sono riferiti ad aria saturata, alla temperatura di 20°C, alla pressione atmosferica di mandata (1013 mbar), e all'impiego di acqua alla temperatura di 15°C. Tolleranza di prestazione ± 10%. Nell'esecuzione in inox la portata diminuisce del 5%. I dati sopraindicati possono essere variati senza preavviso.

The given capacity values are referred to saturated air at the temperature of 20°C, atmospheric discharge pressure (1013 mbar), and of supply of service water at 15°C temperature. Performance tolerance ± 10%. Stainless steel construction is 5% less performing. The data may change without any notice.

a i r m o v i n g