

POMPA PER VUOTO AD ANELLO LIQUIDO

LIQUID RING
VACUUM PUMP

AL890DA

MODELLO AL890DA



La pompa per vuoto ad anello liquido modello AL890DA è del tipo a due stadi per alto vuoto, in esecuzione ad asse nudo, completa di tenute meccaniche. Doppia sopportazione ai lati, versatile nelle prestazioni, raggiunge 33mbar ass., adatta ad aspirare vapori e gas con tracce di liquidi, non necessita di lubrificazione, manutenzione contenuta. Disponibile in versione standard oppure in acciaio inox AISI 316 (parti umide).

The liquid ring vacuum pump model AL890DA is two stage type for deep vacuum, bareshaft version, fitted with single mechanical seals. Between bearing impellers, flexible in performance, achieves 33 mbar abs., suitable to suck vapors and gas with liquid carry over, oil free operation, limited maintenance required. Available in standard version or in ss AISI 316 (wetted parts).



Emmecom s.r.l.

Via P. Nenni, 70
20093 Cologno Monzese (MI)
Tel. +39 02 25 33 300 (r.a.)
Fax +39 02 27 307 908
www.emmecomsrl.com
sales@emmecomsrl.com

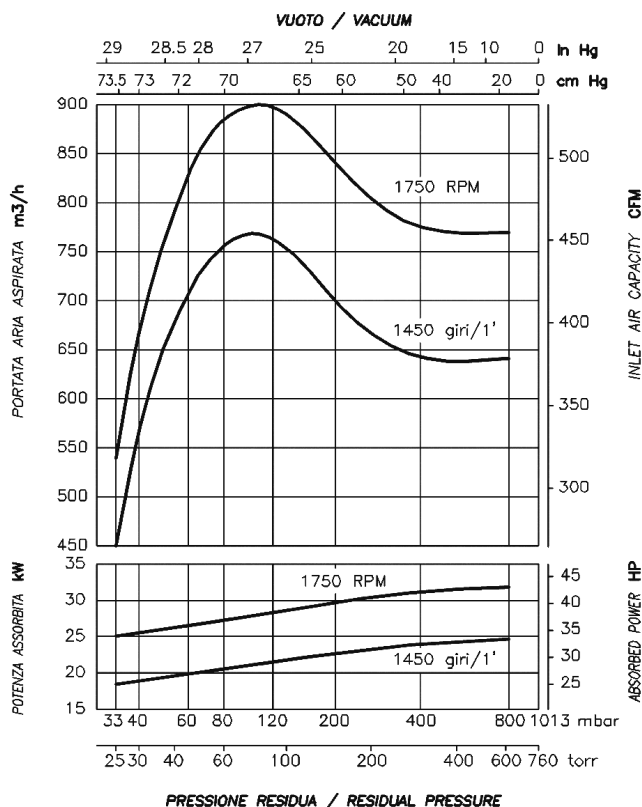

I valori di portata sono riferiti ad aria secca, alla temperatura di 20°C, alla pressione atmosferica di mandata (1013 mbar), e all'impiego di acqua alla temperatura di 15°C. Tolleranza di prestazione ± 10%. Nell'esecuzione in inox la portata diminuisce del 10%. I dati sopraindicati possono essere variati senza preavviso.

The given capacity values are referred to dry air at the temperature of 20°C, atmospheric discharge pressure (1013 mbar), and of supply of service water at 15°C temperature. Performance tolerance ± 10%. Stainless steel construction is 10% less performing. The data may change without any notice.

a i r m o v i n g

POMPA PER VUOTO AD ANELLO LIQUIDO

LIQUID RING
VACUUM PUMP

MODELLO AL890DA



Dimensioni / Dimensions = mm

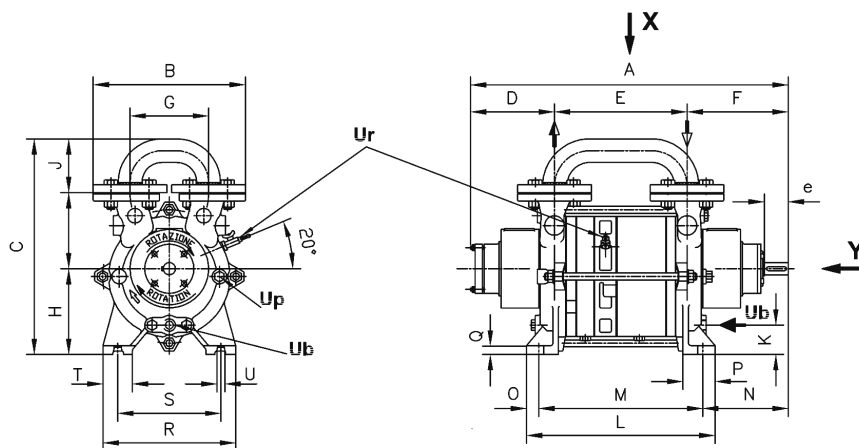

Vista da Y

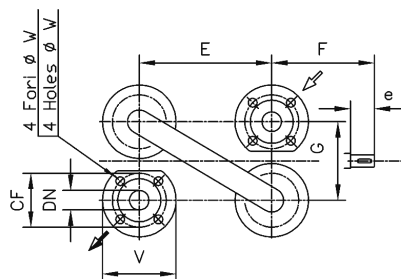

Vista da X

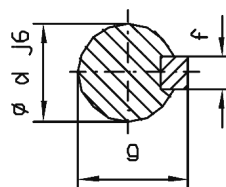

	FLANGE	UNI PN 10			ANSI 150		
		DN	CF	V	W	CF	V
AL890	80 3"	160	200	18	152.4	200	19

AL890DA CONNESSIONI / CONNECTIONS

Ub	1".1/4 GAS F/NPT M	Attacco per liquido di esercizio Service liquid connection
Ur	3/8" GAS	Drenaggio pompa Pump drain
Up	3/8" GAS F	Rompivuoto Relief valve
d	48	Sporgenza d'albero - Shaft end
e	90	Sporgenza d'albero - Shaft end
f	14	Sporgenza d'albero - Shaft end
g	51.5	Sporgenza d'albero - Shaft end

Ub entrata liquido di esercizio
service liquid inlet

Ur valvola anticavitazione
relief valve

Up attacco valvola scarico troppo pieno
overflow valve connection

	A	B	C	D	E	F	G	H	I	J	K	L	M	N	O	P	Q	R	S	T	U	Peso totale - Kg Total Weight - Kg
AL890DA	965	490	640	190	525	255	290	250	220	170	88	640	595	220	22.5	65	20	400	340	80	18	280