

POMPA PER VUOTO AD ANELLO LIQUIDO

LIQUID RING
VACUUM PUMP

AL95L

MODELLO AL95L



La pompa per vuoto ad anello liquido modello AL95L è del tipo monostadio con valvola, in esecuzione lanternata. Compatta, versatile nelle prestazioni, raggiunge 33mbar ass., adatta ad aspirare vapori e gas con tracce di liquidi, non necessita di lubrificazione, manutenzione contenuta. Disponibile in versione standard oppure in acciaio inox AISI 316 (parti umide).

The liquid ring vacuum pump model AL95L is single stage type fitted with vary port valve, in lantern version. Compact, flexible in performance, achieves 33 mbar abs., suitable to suck vapors and gas with liquid carry over, oil free operation, limited maintenance required. Available in standard version or in ss AISI 316 (wetted parts)

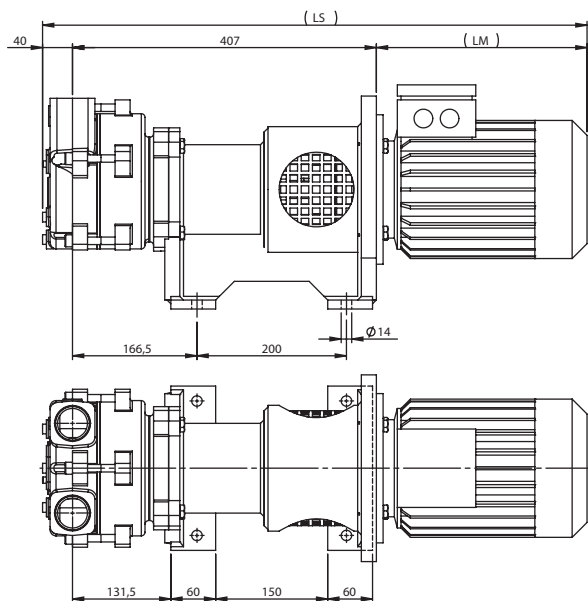

Emmecom s.r.l.

Via P. Nenni, 70
20093 Cologno Monzese (MI)
Tel. +39 02 25 33 300 (r.a.)
Fax +39 02 27 307 908
www.emmecomsrl.com
sales@emmecomsrl.com

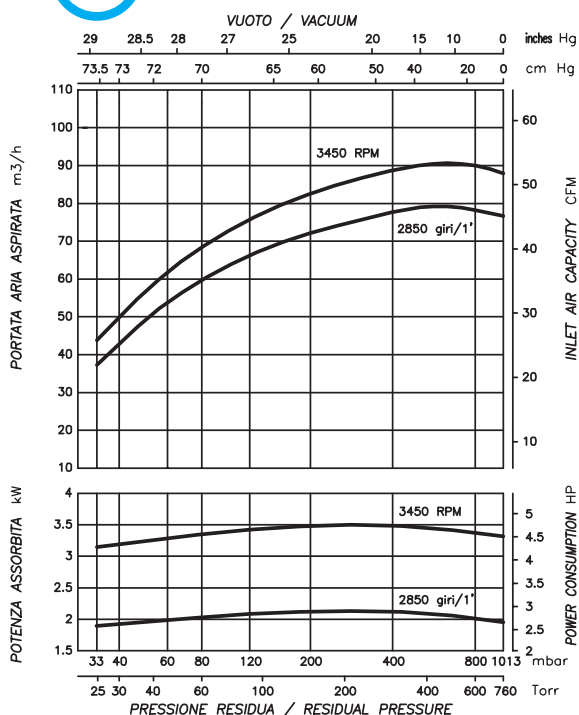

	kW	Hz	IEC	Giri/min rpm	LM	LS	Peso totale - Kg Total Weight - Kg
AL95L50	2.2	50	90	2850	285	732	63
AL95L60	3.5	60	112	3450	335	782	80

S	G1"1/2	Aspirazione Suction
D	G1"1/2	Mandata Discharge
Ub	G1/4"	Anello liquido Service liquid
Ue	G1/4"	Drenaggio pompa Pump drain
Ur	M5	Anticavitazione Anticavitation

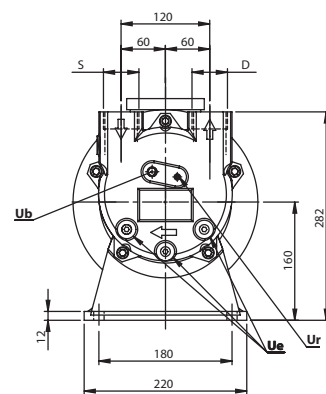

I valori di portata sono riferiti ad aria secca, alla temperatura di 20°C, alla pressione atmosferica di mandata (1013 mbar), e all'impiego di acqua alla temperatura di 15°C. Tolleranza di prestazione ± 10%. Nell'esecuzione in inox la portata diminuisce del 10%. I dati sopraindicati possono essere variati senza preavviso.

The given capacity values are referred to dry air at the temperature of 20°C, atmospheric discharge pressure (1013 mbar), and of supply of service water at 15°C temperature. Performance tolerance ± 10%. Stainless steel construction is 10% less performing. The data may change without any notice.

a i r m o v i n g