

COMPRESSORI-ASPIRATORI A CANALE LATERALE

SIDE CHANNEL COMPRESSORS AND VACUUM PUMPS

SC341MG

MODELLO SC341MG0.81T - SC341MG0.94M

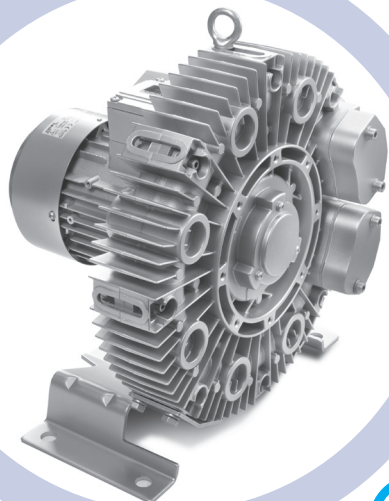

Costruiti secondo il principio dei canali laterali, funzionano sia in aspirazione sia in compressione e sono progettati per lavorare a servizio continuo. Realizzato in alluminio pressofuso garantisce la massima robustezza e maneggevolezza. Non occorre lubrificazione in quanto non c'è contatto tra le parti statiche e rotanti. Particolari silenziosi contribuiscono ad ottenere un elevato livello di silenziosità.

Construction of the ring blowers fans is based on the lateral ducts principle. The blowers can operate as either exhaust or compression fans and are designed for continuous service. The device is assembled directly on the motor shaft; all the rotating parts are dynamically balanced to ensure absolute absence of vibration. Full die-cast aluminium construction for maximum sturdiness and ease of handling.



Curve Curva n.	Model Modello n.	Frequency Frequenza (Hz)	Output power Potenza (kW)	Voltage Vollaggio (V)	Rated current Assorbimento (A)	Noise Rumorosità dB (A)	Weight Peso (Kg)
1	SC341MG0.81T	50	0.81	200-240 Δ 345-415Y	4.0 Δ/2.3Y	59	17
2	SC341MG0.81T	60	0.94	220-275 Δ 380-480Y	4.0 Δ/2.3Y	62	17
3	SC341MG0.94M	50	0.94	220-240	9.0	57	18
4	SC341MG0.94M	60	1.1	220-240	9.0	62	18



Emmecom s.r.l.

Via P. Nenni, 70
20093 Cologno Monzese (MI)
Tel. +39 02 25 33 300 (r.a.)
Fax +39 02 27 307 908
www.emmecomsrl.com
sales@emmecomsrl.com



ASPIRAZIONE / EXHAUST

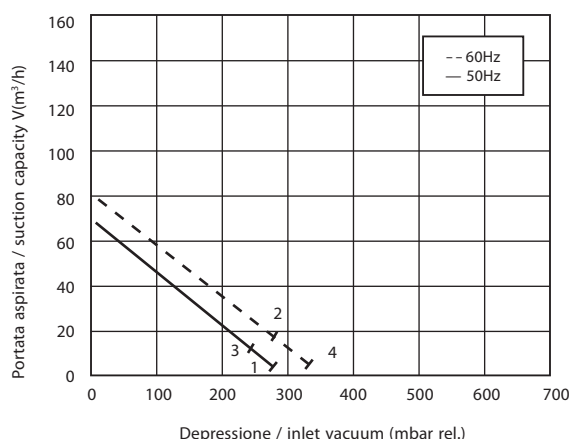

COMPRESSIONE / COMPRESSION

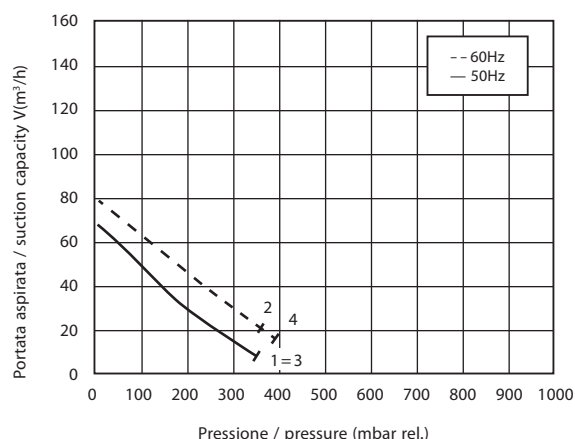

I valori di portata e pressione si intendono per il convogliamento dell'aria avente in aspirazione temperatura di 15°, densità di 1,23 kg/m³ e pressione a 1.013 mbar. La tolleranza di queste curve si intende del ±10%. I dati sopraindicati possono essere variati senza preavviso.

The characteristic data given here refer to the handling of gas with inlet temperature of 15° C, normal density of 1,23 kg/m³ and absolute pressure of 1.013 mbar. Tolerance of ±10%. The data may change without any notification.

a i r m o v i n g

COMPRESSORI-ASPIRATORI A CANALE LATERALE

SIDE CHANNEL
COMPRESSORS AND
VACUUM PUMPS

MODELLO SC341MG0.81T - SC341MG0.94M

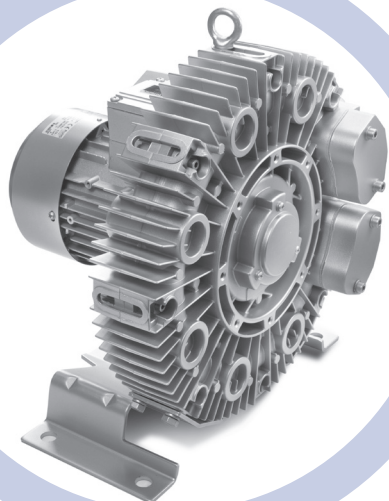

Dimensioni / Dimensions = mm

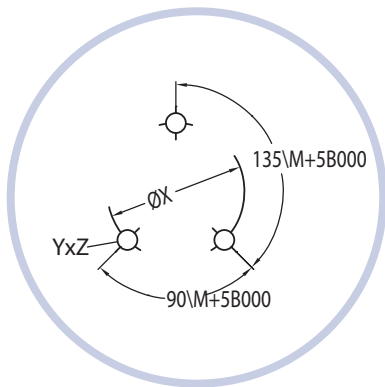
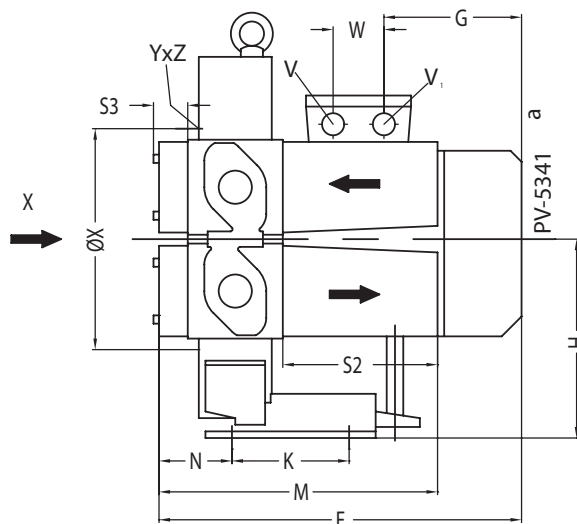
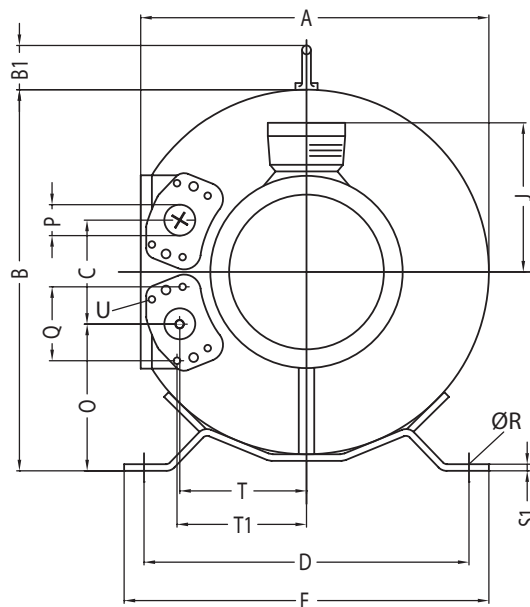

Emmecom s.r.l.

Via P. Nenni, 70
20093 Cologno Monzese (MI)

Tel. +39 02 25 33 300 (r.a.)
Fax +39 02 27 307 908

www.emmecomsrl.com
sales@emmecomsrl.com

	Curve Curva	A	B	B ¹	B1	C	C2	D	E	F	G	H	H1	J	K	M	N	O	P
SC341MG0.81T	1 / 2	313	339	—	39	94	—	290	325	295	129	177	—	120	105	256	67	130	G1 ¹ / ₄
SC341MG0.94M	3 / 4	313	339	—	39	94	—	290	325	295	129	177	—	120	105	256	67	130	G1 ¹ / ₄

	Curve Curva	Q	R	S1	S2	S3	T	T1	U	V	V1	W	X	Y X Z
SC341MG0.81T	1 / 2	64	14	4	140	31	114	116	M6 x 17	M25 X 1.5	M16 x 1.5	32	153	M6 x 15
SC341MG0.94M	3 / 4	64	14	4	140	31	114	116	M6 x 17	M25 X 1.5	M16 x 1.5	32	153	M6 x 15